

TECHNICAL GUIDE

AND PARTS LIST

CAL. V001A

COMBINATION QUARTZ

CONTENTS

I. SPECIFICATIONS	1
II. CIRCUIT BLOCK SCHEMATIC	1
III. TIME SETTING AND DISPLAY FUNCTION	2
IV. DISASSEMBLING, REASSEMBLING AND LUBRICATING	3
1. Hands ~ Hour wheel	3
2. Circuit block screw ~ Switch lever bush	4
3. Coil block screw ~ Rotor stator	5
4. Setting lever spring screw ~ Main plate	6
V. CLEANING	7
VI. CHECKING AND ADJUSTMENT	8
1. Guide table for checking and adjustment	8
(Analogue section)	
(Digital section)	
2. Procedure for checking and adjustment	10
A. Check output signal	10
B. Check battery voltage	10
C. Check conductivity of circuit block, connector and liquid crystal panel	10
D. Check circuit block and liquid crystal panel	11
E. Check current consumption	12
F. Check coil block	13
G. Check reset and train wheel setting condition	13
H. Check alarm test system	14
I. Check alarm function	14
J. Check accuracy	15
K. Check functioning and adjustment	15
L. Check conductivity of switch components	15
VII. PARTS LIST	17

I. SPECIFICATIONS

Item	Cal. No.	V001A
Indication and display system	Analogue section	Digital section
	Three hands	Nematic Liquid Crystal FEM (Field Effect Mode)
Driving system	Step motor	Multiplex
Display system		<ul style="list-style-type: none"> ● Time display ● Second display ● Day and date display ● Month and date display ● Alarm display (Sounds for 20 seconds)
Additional mechanism	<ul style="list-style-type: none"> ● Electric circuit reset switch ● Second setting device 	<ul style="list-style-type: none"> ● Alarm test
Loss/gain	Loss/gain at normal temperature range Monthly rate: Less than 20 seconds	
Casing diameter	φ 21.0 mm (12H - 6H: 19.2 mm/3H - 9H: 17.4 mm)	
Height (Including battery)	2.9 mm (3.3 mm)	
Regulation system	Trimmer condenser	
Measuring gate by Quartz Tester	Any gate is available (Measure with the analogue section.)	
Battery	SEIZAIKEN TR726W Voltage: 1.55V Battery life: Approx. 2 years	
Jewels	2 jewels	

II. CIRCUIT BLOCK SCHEMATIC

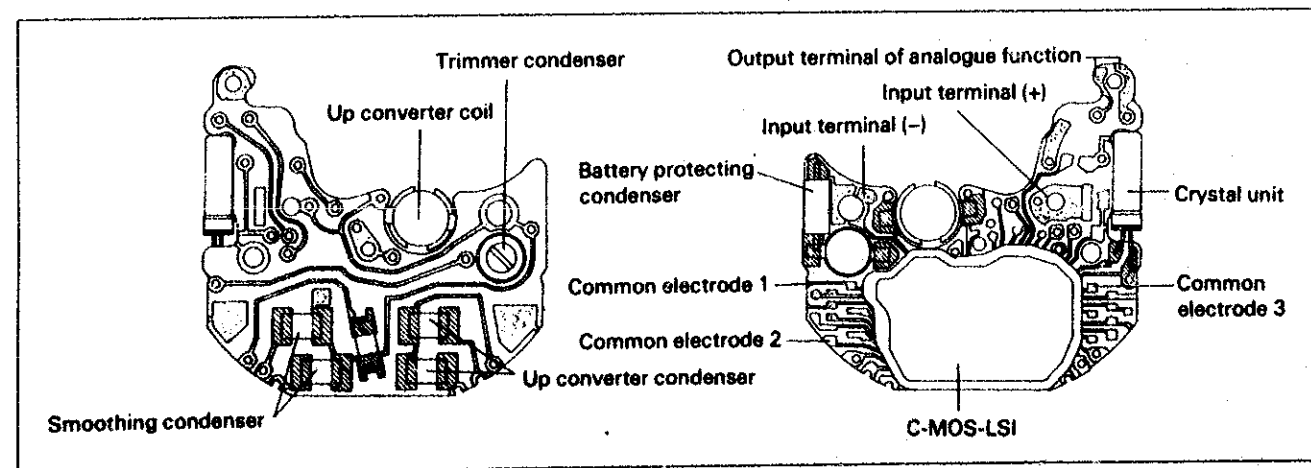

III. TIME SETTING AND DISPLAY FUNCTIONS

● Names and functions

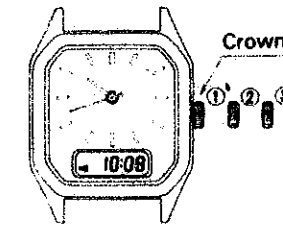

- ① Normal position: Digital display can be selected.
 - ② First click position: Digital calendar, time, alarm time can be set.
 - ③ Second click position: Analogue time can be set.
- * To set the time, etc, the crown rotational direction is the same for both analogue and digital displays.

⌚ Clockwise - To go back ⌚ Counterclockwise - To advance

● Time setting for digital display

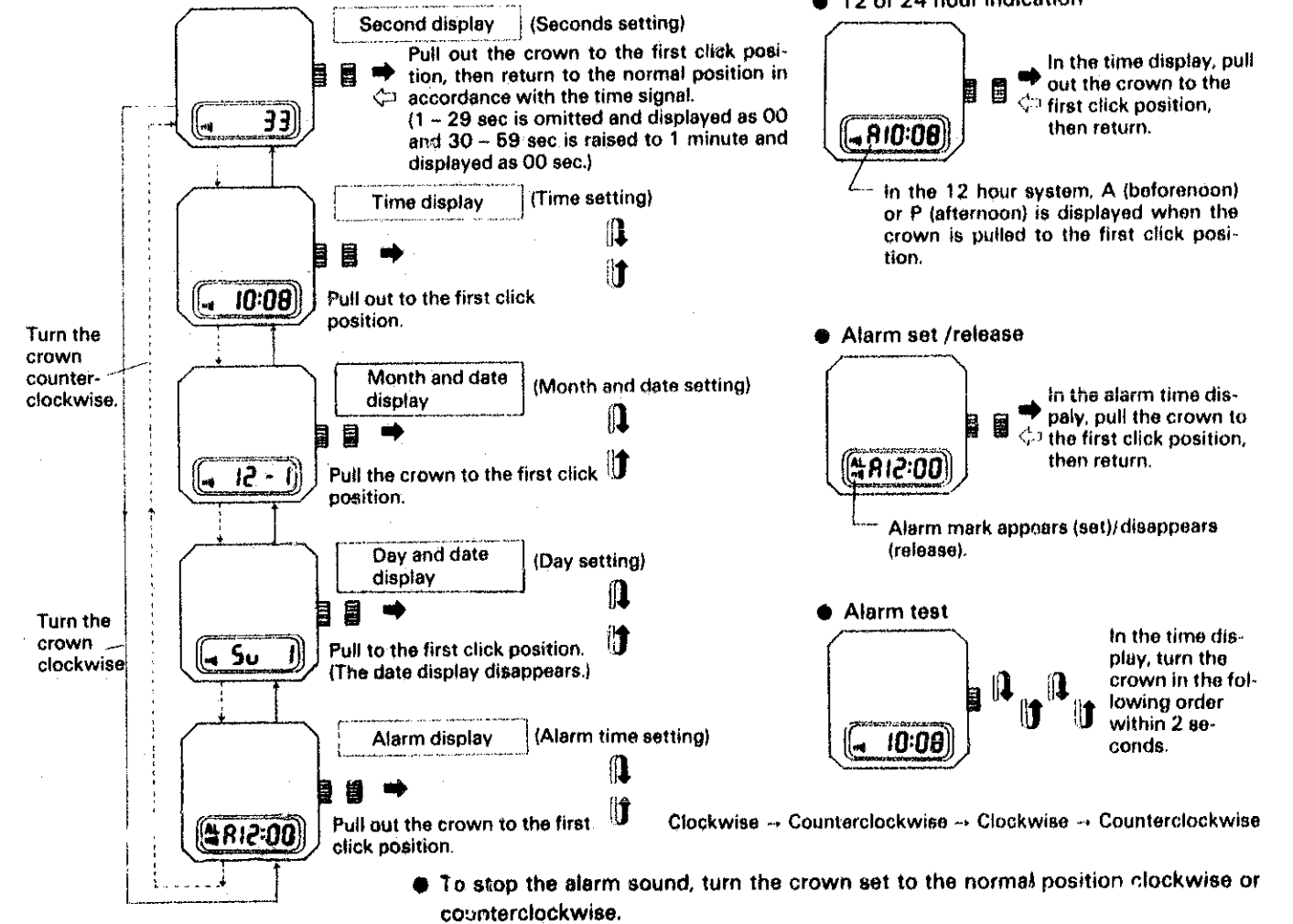

● Time setting for analogue indication

*Set the current time of the analogue section later.

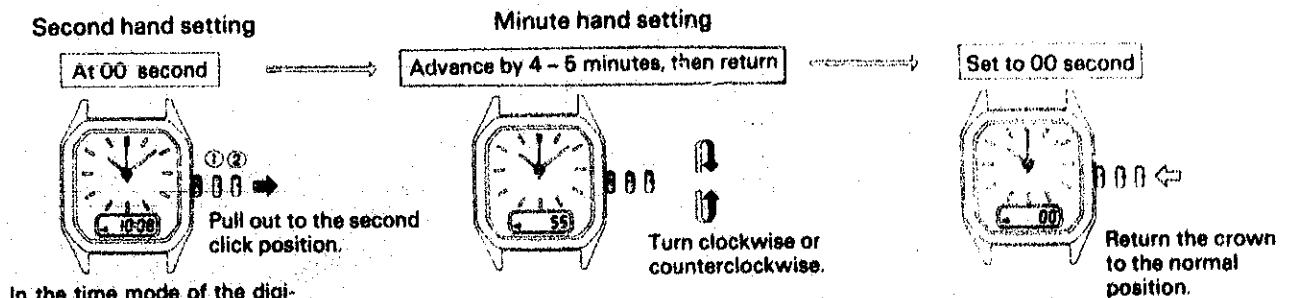

IV. DISASSEMBLING, REASSEMBLING AND LUBRICATING

● Disassembling and reassembling

Disassembling procedures: Figs 1 ~ 5

Reassembling procedures: Figs 5 ~ 1

- Be sure to use the movement holder S-676

● Lubricating

Types of oil



Moebius A 

Moebius Synt-V-Lube 

Oil quantity 

Normal 

● List of used screw

Shape	Parts No.	Name	Shape	Parts No.	Name
	012 198	Train wheel bridge screw (2 pcs.)		012 793	Setting lever spring screw (4 pcs.)
		Circuit block screw (3 pcs.)			
		Coil block screw (1 pc.)			

1. Hands ~ Hour wheel

● Hour, minute and second hands

When installing the hands, take care not to deform the train wheel bridge.

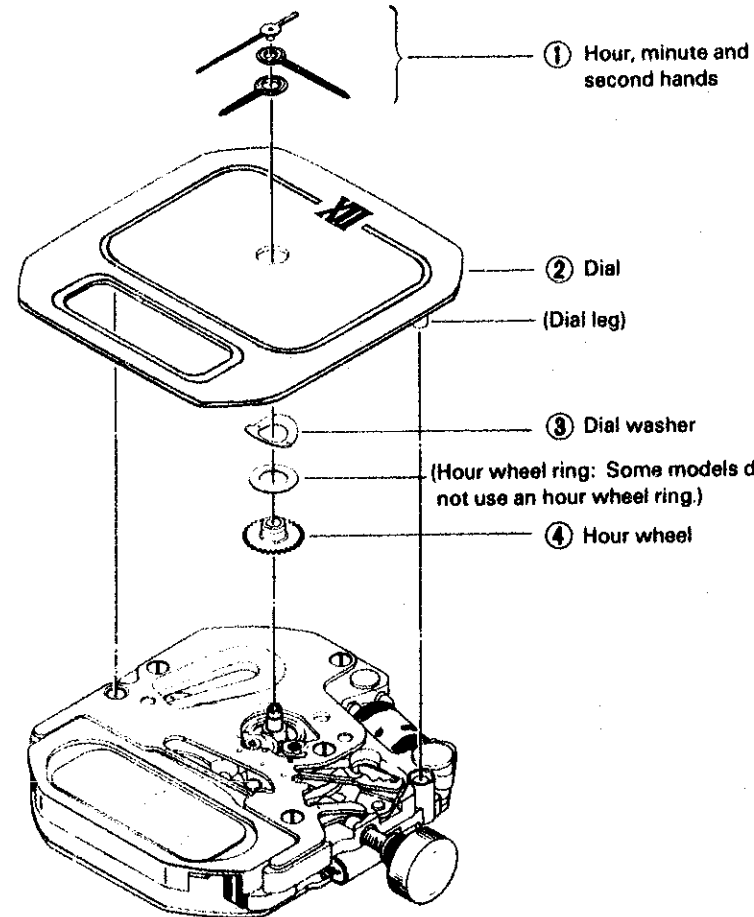

● Dial

The dial is fixed by putting the dial leg into the hole on the liquid crystal panel frame. When disassembling the dial, insert the tip of the screwdriver in the arrowmark-portioned notches of the illustration on the right and pry it up alternately. When reassembling the dial, set it evenly.

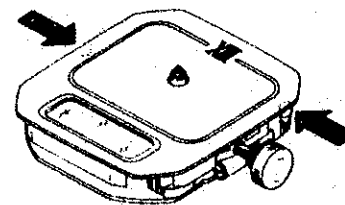

2. Circuit block screw ~ Switch lever bush

- Speaker lead terminal
Set the speaker lead terminal as shown in the illustration below.

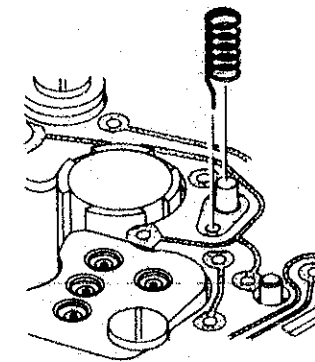

● How to reassemble the switch mechanism.

Set one end of the switch lever to the smaller opening of contact point lever and the other end to the open end of switch lever spring.

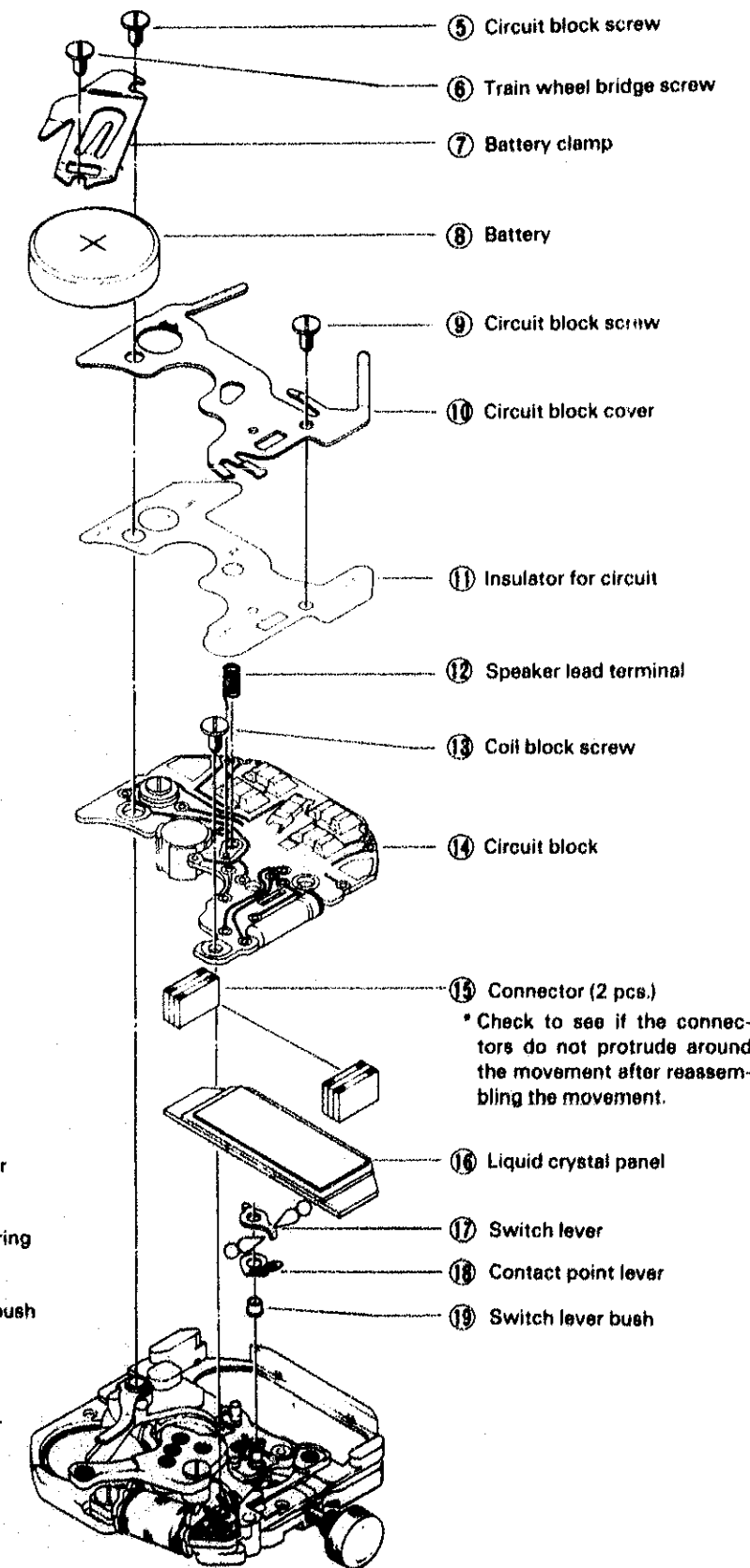
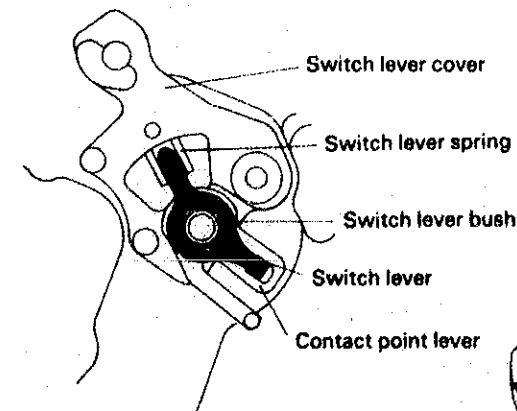

3. Coil block screw ~ Rotor stator

● Gear train locations

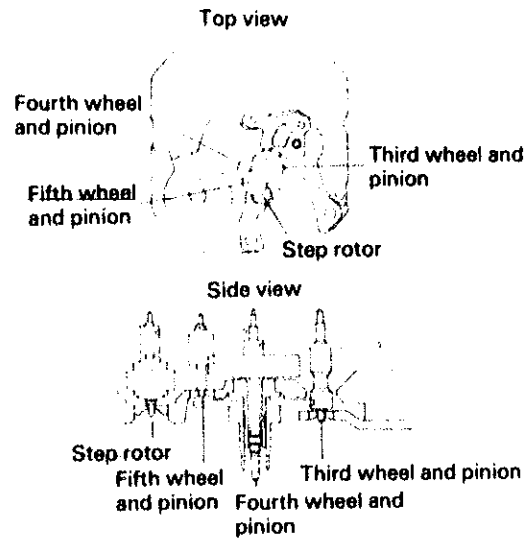

● Switch lever spring and train wheel setting lever.

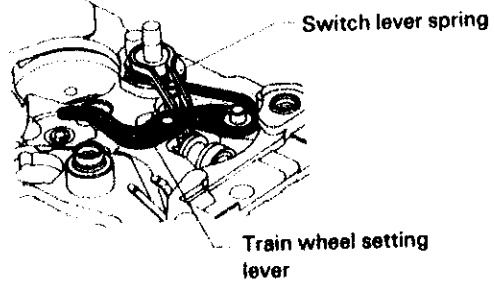

* Reassemble the train wheel setting lever with the crown in the second click position. After reassembling it, push the crown back to the normal position.

● Changeover switch spring

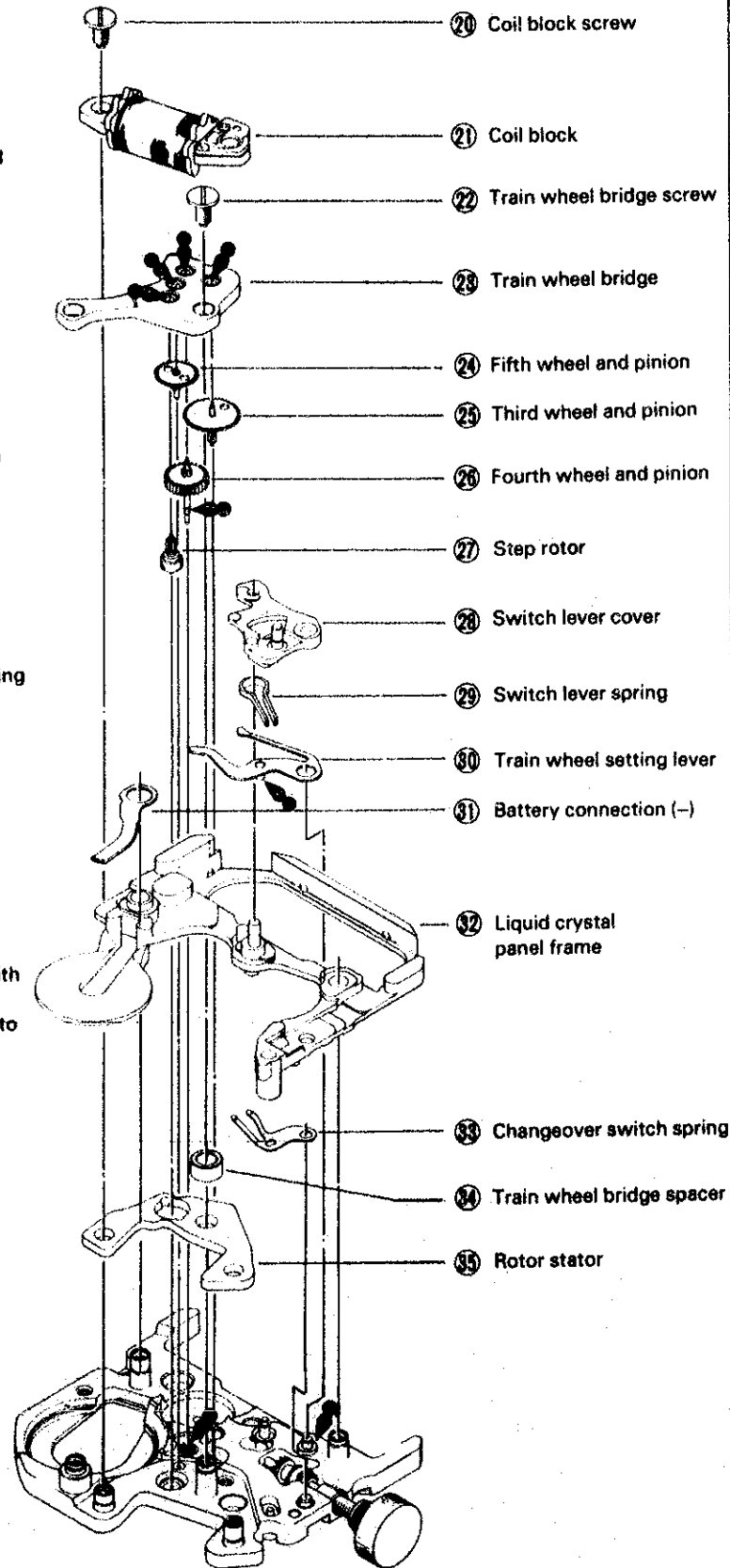
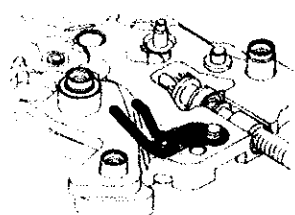

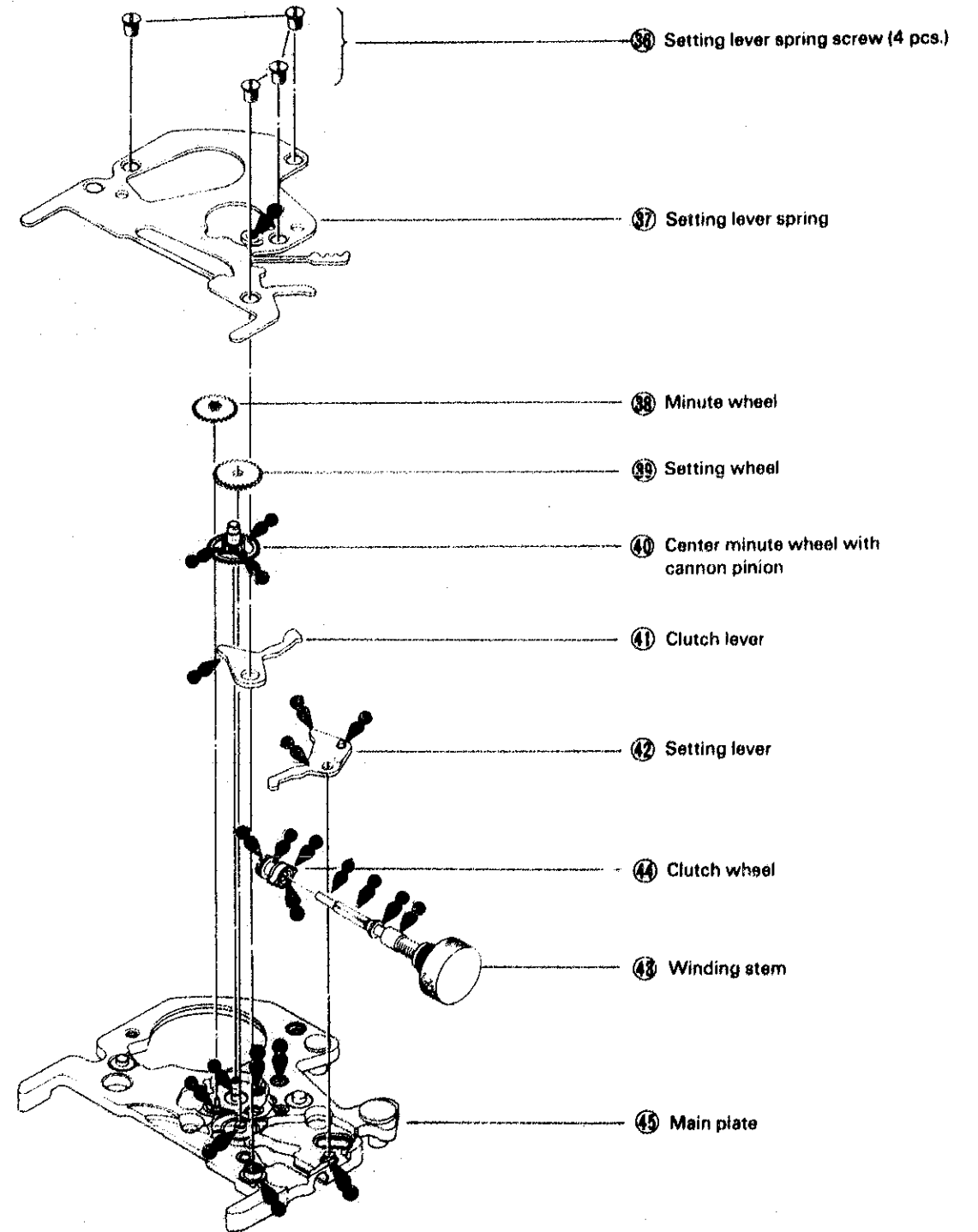

4. Setting lever spring screw ~ Main plate

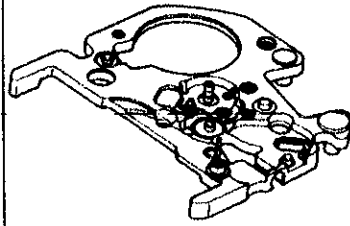

V. CLEANING

1. How to clean

Name of parts	Cleaning	Drying	Solution	Remarks
Main plate  Step rotor 	Rinse or scrub with a soft brush	Warm air	Benzene	<ul style="list-style-type: none"> ● Be careful not to deform or remove the parts fixed to the main plate. ● Use a clean solution as the step rotor is magnetized. Any foreign matter which cannot be removed by cleaning should be removed with rodico.
Connector 	Rinse or clean with a soft brush.	Warm air	Alcohol	<ul style="list-style-type: none"> ● Never use benzene or trichloroethylene as these will melt the connector. ● Do not install a connector until it is completely dry.
Plastic parts Panel frame Circuit block insulator Switch lever cover	Rinse or clean with a soft brush	Warm air	Alcohol or benzene	
Other parts (excluding parts that must not be cleaned.)	Clean with a cleaner, rinse or gently scrub with a soft brush.	Warm air	Alcohol or benzene	

2. Parts that must not be cleaned

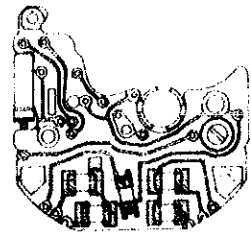

Circuit block



Liquid crystal panel



Coil block



Battery

- Clean only the contacts of the liquid crystal panel and circuit block with a cloth moistened with benzene or alcohol and blow dry with warm air.
- Remove dust or lint with a soft brush.

VI. CHECKING AND ADJUSTMENT

1. Guide table for checking and adjustment (Analogue section)

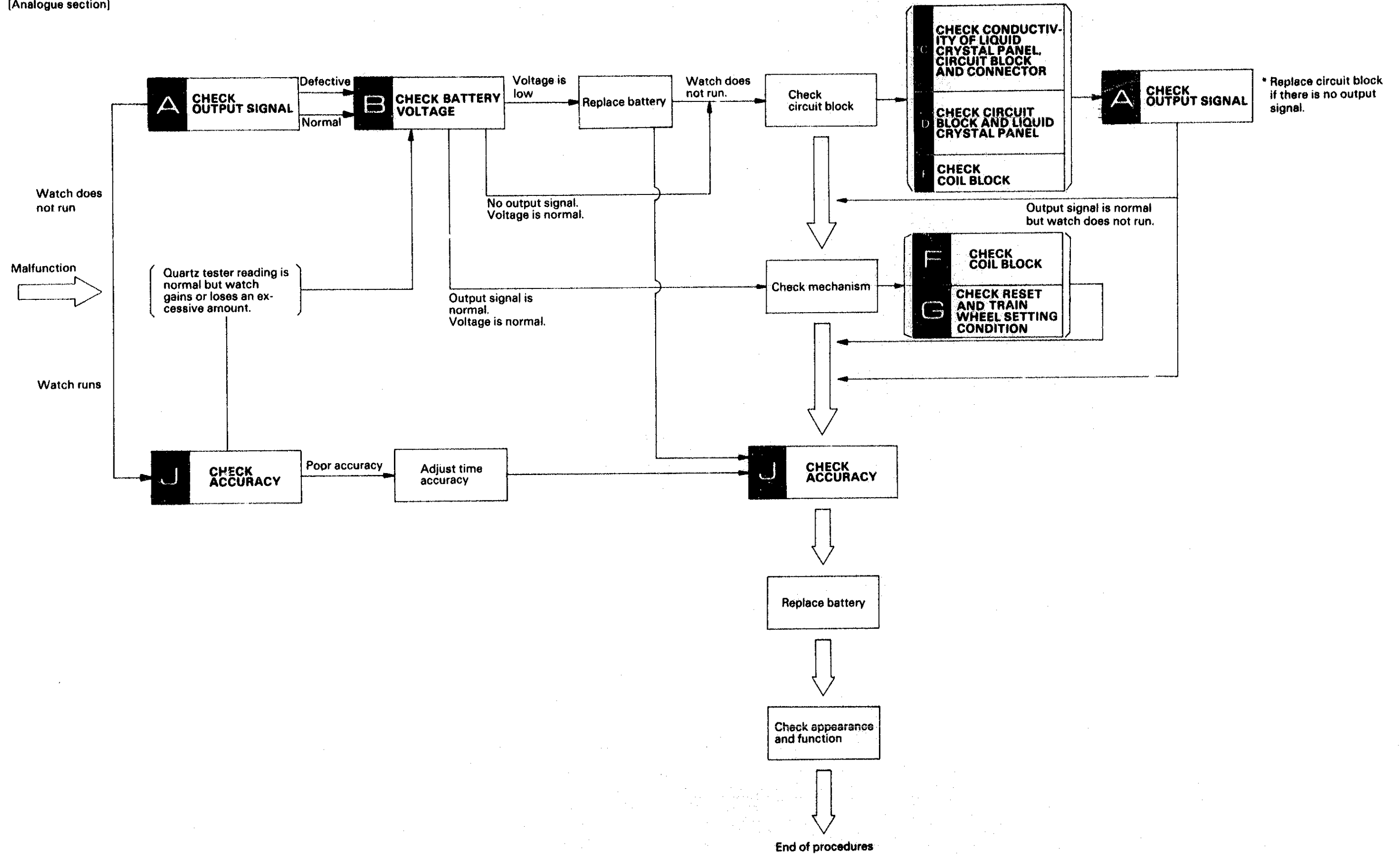

(Digital section)

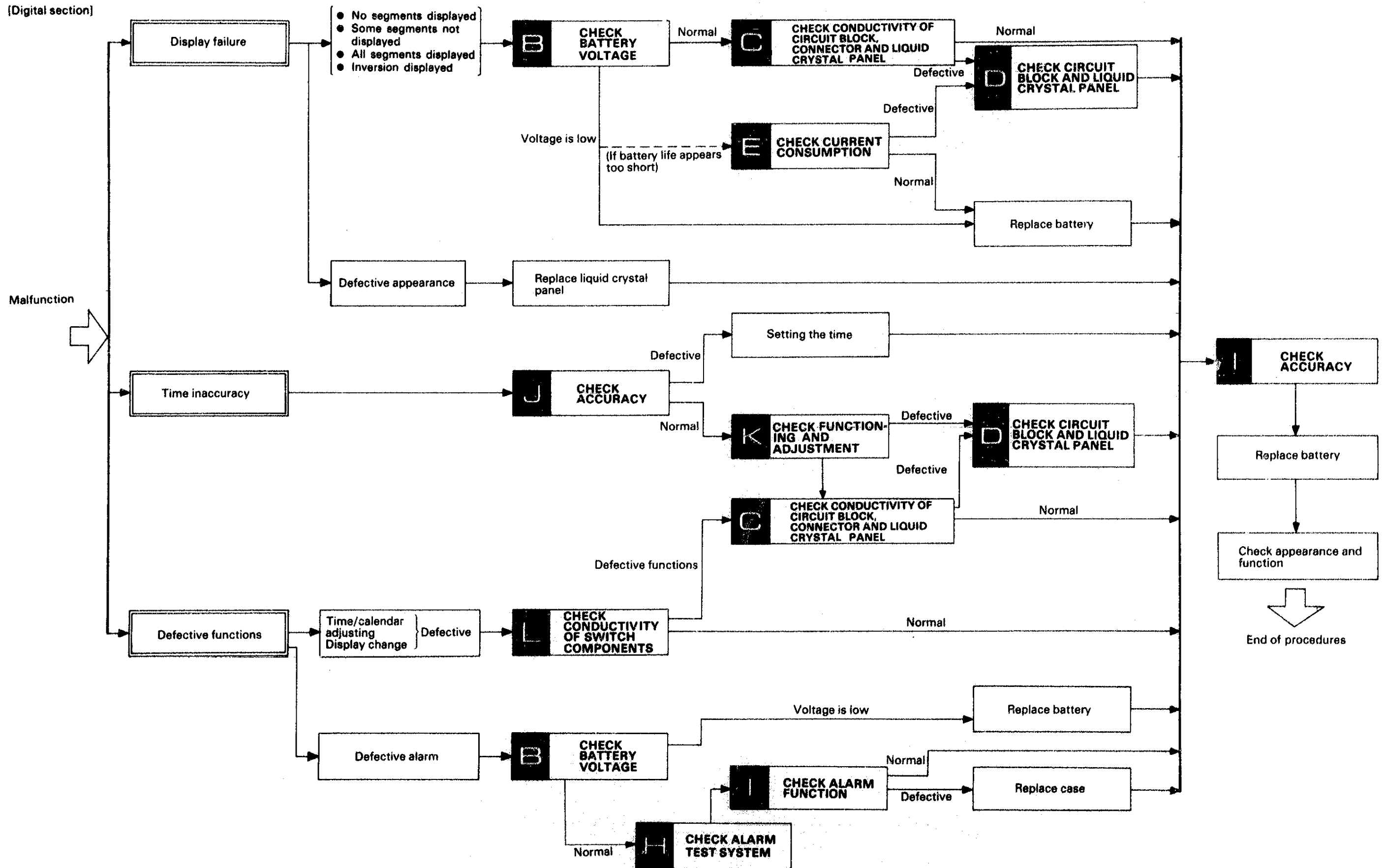

2. Procedure for checking and adjustment

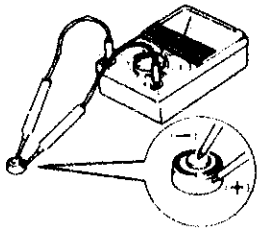
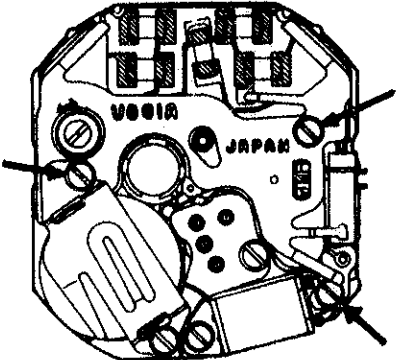
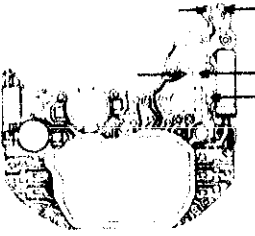
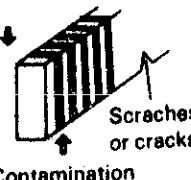
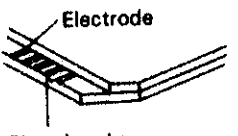
	Procedure	Result and repair
CHECK OUTPUT SIGNAL	<p>Check output signal of the watch.</p> <ul style="list-style-type: none"> ● Set up the quartz tester. ● Use an electromagnetic microphone for the analogue watch. 	<p>Blinks every second: Normal Does not blink: Defective</p>
CHECK BATTERY VOLTAGE	<p>Check battery voltage</p> <ul style="list-style-type: none"> ● Set up the Volt-ohm-meter. Range to be used: DC 3V ● Measuring Red probe (+)...Battery surface (+) Black probe (-)...Battery surface (-) 	<p>1.5V or more: Normal Less than 1.5V: Defective</p>
CHECK CONDUCTIVITY OF CIRCUIT BLOCK, CONNECTOR AND LIQUID CRYSTAL PANEL	<p>(1) Check the screws for tightness.</p>  <p>(2) Check for dust, lint contamination, cracks and breakes of conductive portion.</p> <div style="display: flex; justify-content: space-around;"> <div style="text-align: center;"> <p>Circuit block</p>  <p>Check three side surfaces of the switch components and output terminal for analogue.</p> </div> <div style="text-align: center;"> <p>Connector</p>  <p>Scratches or cracks Contamination dust or lint</p> </div> <div style="text-align: center;"> <p>Liquid crystal panel</p>  <p>Electrode Glass breaks</p> </div> </div>	<p>No loose screws: Normal Proceed to (2) Loose screws: Defective Retighten</p> <p>Uncontaminated: Normal Contaminated: Defective Wipe off any foreign matter.</p> <p>No scratches, cracks or breaks: Normal Scratches, cracks or breaks: Defective Replace the parts with new ones.</p>

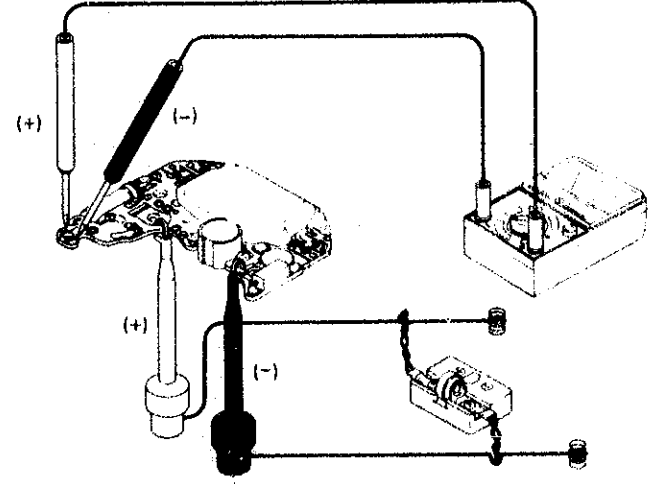
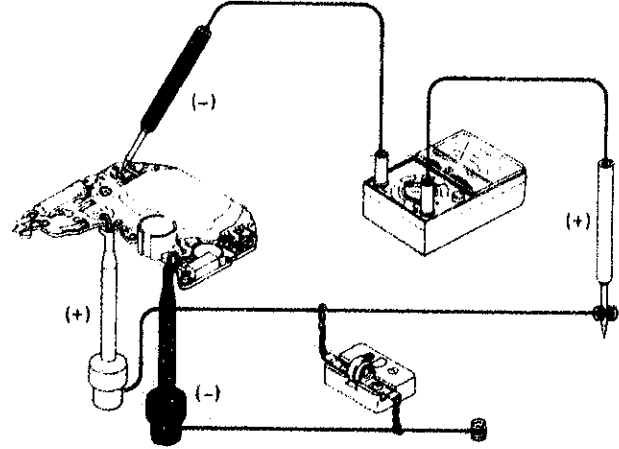
	Procedure	Result and repair
CHECK CIRCUIT BLOCK AND LIQUID CRYSTAL PANEL	<p>(1) Check electric signal from circuit block.</p> <ol style="list-style-type: none"> ① Remove circuit block from the module. ② Connect circuit block to the Volt-ohm-meter and power supplier as illustrated below. <ul style="list-style-type: none"> ● Analogue terminals Volt-ohm-meter measuring range: DC 3V  <p>* Either red or black probe will do.</p> <ul style="list-style-type: none"> ● Digital terminals Volt-ohm-meter measuring range: DC 3V 	<p>The pointer swings every second: Normal The pointer does not swing: Defective Replace circuit block.</p> <p>0.8v or more: Normal Less than 0.8V: Defective. Replace circuit block.</p>

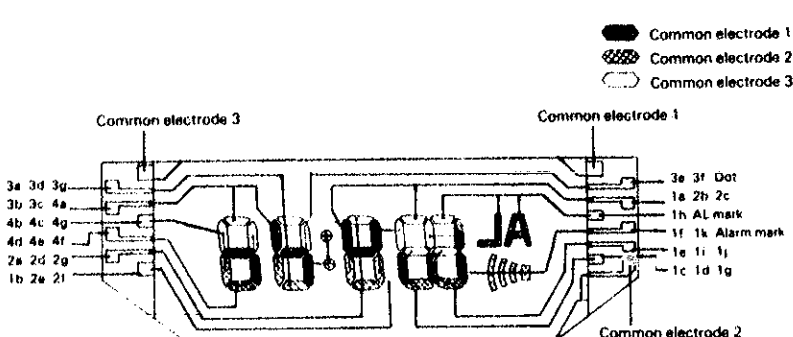
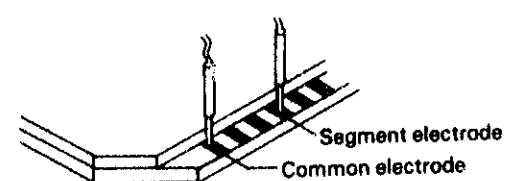
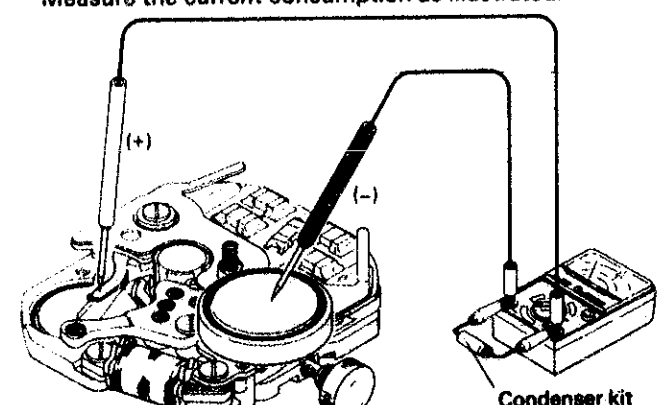
	Procedure	Result and repair
CHECK CIRCUIT BLOCK AND LIQUID CRYSTAL PANEL	<p>(2) Check the liquid crystal panel for broken wire and short-circuit.</p> <ol style="list-style-type: none"> Turn the liquid crystal panel to the reverse side. Set up the Volt-ohm-meter. Range to be used: OHMS x 1 (Any range will do if more than 3V is applied to the terminal of the Volt-ohm-meter.) Attach the probes to the common electrode and segment electrodes of the liquid crystal panel. (Either red or black probe will do.)   <p>* Common electrode 1 is connected electrically with segment.</p>	<p>Displayed: Normal Not displayed: Defective Replace the liquid crystal panel with a new one.</p>
CHECK CURRENT CONSUMPTION	<p>Check if the current consumption is normal.</p> <ol style="list-style-type: none"> Set up the Volt-ohm-meter. Range to be used: DC 12 μA Measuring Red probe (+)...Battery connection (-) Black probe (-)...Battery surface(-) Measure the current consumption as illustrated.  <p>* When measuring the current consumption, take care not to allow the incandescent lamp light to emit to the movement and circuit block. If the movement and circuit block is lit, the measured value tends to become larger.</p>	<p>Less than 2.2 μA: Normal 2.2 μA or more: Defective. Replace the circuit block or liquid crystal panel with a new one.</p>

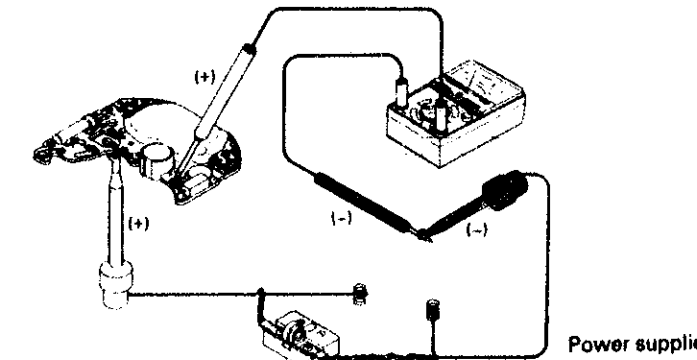
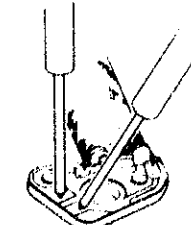
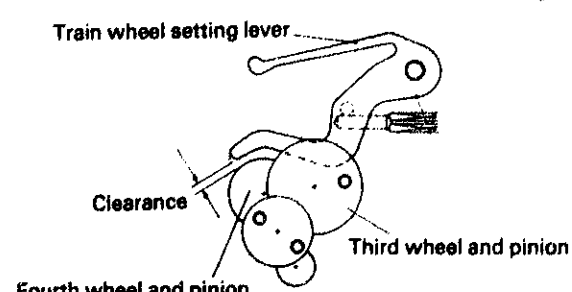
	Procedure	Result and repair
CHECK CURRENT CONSUMPTION	<p>If the current consumption is large, check as follows.</p> <ol style="list-style-type: none"> Measure the current consumption when the coil block is removed from the module. * Connection is the same as previous. Measure the current consumption of only circuit block. 	<p>Less than 1.8 μA: Normal. Check for lubrication, dust and lint on train wheel and converters. Check coil block. 1.8 μA or more: Defective. Proceed to (2)</p> <p>Less than 1.5 μA: Circuit block is normal. Replace liquid crystal panel. 1.5 μA or more: Circuit block is defective. Replace circuit block.</p>
CHECK COIL BLOCK	<p>Check the coil block for short circuit and broken wire.</p> <ol style="list-style-type: none"> Set up the Volt-ohm-meter. Before checking, be sure to make a 0Ω adjustment. Range to be used: OHMS x 100 Checking Apply red and black probes of the Volt-ohm-meter to the coil block leads. 	<p>3.2k Ω ~ 3.8k Ω: Normal. Less than 3.2k Ω (short circuit): More than 3.8k Ω (broken wire): Defective. Replace coil block.</p>
CHECK RESET AND TRAIN WHEEL SETTING CONDITION	<p>Check that the reset and train wheel setting condition is normal.</p> <ol style="list-style-type: none"> When the crown is pulled out to the second click position, the second hand should stop. When the crown is returned to the first click position or normal position, the second hand should start moving after 1 second. (This can be checked with the Quartz tester output signal.)  <ol style="list-style-type: none"> Check the clearance between the train wheel setting lever and fourth wheel and pinion. * The crown should be positioned at the normal or first click position. <p>* Second click position</p>	<p>The second hand stops when the crown is pulled out to the second click position and starts moving after 1 second when the crown is set to the normal position: Normal The second hand does not stop when the crown is pulled out to the second click position and moves irregularly when the crown is returned to the normal position: Defective * Check the changeover switch spring and second setting condition.</p> <p>There is a clearance: Normal There is no clearance: Defective Replace the train wheel setting lever.</p> <p>There is a clearance: Normal There is no clearance: Defective Replace the train wheel setting lever.</p>

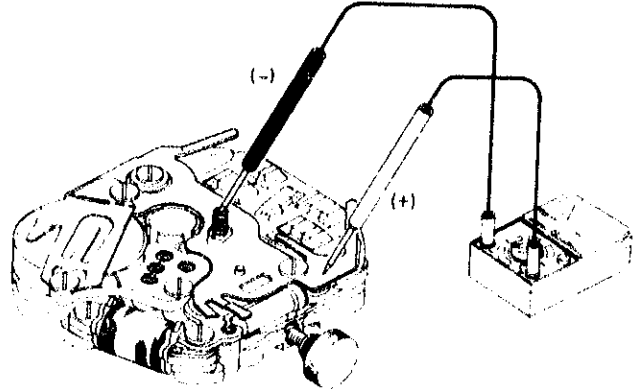
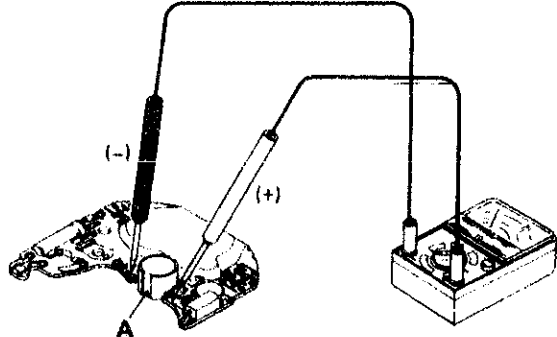
	Procedure	Result and repair
CHECK ALARM TEST SYSTEM	<p>In the time display of digital section, turning the crown in the following order, clockwise → counterclockwise → clockwise → counterclockwise within 2 seconds will enter the watch to the alarm test mode.</p>	<p>Alarm sounds: Normal Alarm does not sound: Defective Proceed to ■</p>
CHECK ALARM FUNCTION	<p>If the alarm does not sound, check the followings.</p> <p>(1) Check alarm output signal from circuit block.</p> <ol style="list-style-type: none"> Set digital display to time display. Set up the Volt-ohm-meter. Range to be used: DC 3V or DC 12 μA. Red probe (+)...Circuit block cover Black probe (-)...Speaker lead terminal Turn the crown in the following order and the alarm will ring. Clockwise → Counterclockwise → Clockwise → Counterclockwise  <p>(2) Check up-converter coil for a broken wire or short-circuit</p> <ol style="list-style-type: none"> Set up the Volt-ohm-meter. Range to be used: OHMS x 1 Check according to the figure. Always calibrate the Volt-ohm-meter beforehand.  <p>(3) Check piezo electric element If the alarm does not function even when alarm output signal is normal, check the piezo electric element for scratches and cracks and check the speaker lead terminal for connection.</p>	<p>The pointer swings: Normal. Proceed to step (3). The pointer does not swing: Defective. Proceed to step (2) Up-converter coil checking.</p> <p>In case the color of portion A (arrow marked) is white or blue.</p> <p>70Ω ~ 90Ω: Normal Less than 70Ω: Defective (short circuit) More than 90Ω: Defective (broken wire) Replace the circuit block with a new one.</p> <p>In case the color of portion A is red.</p> <p>110Ω ~ 170Ω: Normal Less than 110 Ω: Defective (short circuit) More than 170Ω: Defective (broken wire) Replace the circuit block.</p>

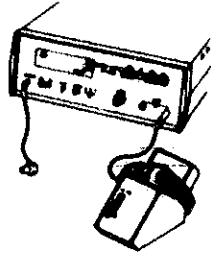
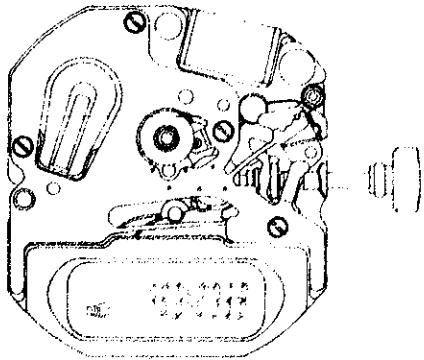
	Procedure	Result and repair
CHECK ACCURACY	<p>Check gain and loss of time by using the Quartz Tester.</p> <ol style="list-style-type: none"> Set up the Quartz Tester Use an electromagnetic microphone for analogue watch. Measuring. 	<p>Does not gain or loss: Normal. Gain or losses: Defective. Adjust the time accuracy by the trimmer condenser.</p>
CHECK FUNCTIONING AND ADJUSTMENT	<p>Check if operations listed below can be performed according to the procedures on page 2.</p> <ul style="list-style-type: none"> Analogue watch: Time setting Digital watch: Time setting Calendar setting Alarm time setting 	
CHECK CONDUCTIVITY OF SWITCH COMPONENTS	<p>* Check after reassembling the battery to the movement.</p> 	

Procedure	Result and repair
<p>(Digital function)</p> <p>(1) Turn the crown counterclockwise or clockwise at the normal position.</p>	<p>When turned, it clicks and the display changes: Proceed to (2)</p> <p>When turned, it clicks but the display does not change: Defective</p> <p>When turned, it does not click and the display does not change: Defective</p> <p>* Check setting position of switch lever and switch lever spring.</p> <p>* Check setting position of contact point lever and switch lever.</p> <p>* Check the contact portion of contact point lever and circuit block.</p>
<p>(2) Pull the crown to the first click and turn it counterclockwise or clockwise in each display.</p>	<p>The digits advance when the crown is turned counterclockwise and they go back when the crown is turned clockwise: Normal</p> <p>The digits do not advance or go back when the crown is turned counterclockwise or clockwise: Defective</p> <p>* Check the contact portion of changeover switch spring and circuit block.</p> <p>* Check setting position of changeover switch spring.</p>

VII. PARTS LIST for Cal. V001







PART NO.	PART NAME	PART NO.	PART NAME
125 302	Train wheel bridge	4239 302	Rotor stator
231 302	Third wheel & pinion	4245 302	Changeover switch spring
*241 305	Fourth wheel & pinion	4246 302	Speaker lead terminal
261 260	Minute wheel	4247 302	Switch lever bush
*270 305	Center minute wheel with cannon pinion	4270 302	Battery connection (-)
*271 266	Hour wheel	4282 302	Contact point lever
281 302	Setting wheel	4313 302	Connector
282 302	Clutch wheel	4398 309	Liquid crystal panel frame
351 302	Winding stem	4450 302	Switch lever
383 302	Setting lever	4456 302	Switch lever cover
384 302	Yoke (clutch lever)	* 4457 306	Circuit block cover
386 302	Setting lever spring	4510 151	Liquid crystal panel (silver)
391 302	Train wheel setting lever	4510 152	Liquid crystal panel (gold)
426 302	Train wheel bridge support	011 541	Upper hole jewel for step rotor
491 141	Dial washer	011 541	Lower hole jewel for step rotor
493 260	Hour wheel ring (Thickness 0.03 mm, gold)	012 198	Train wheel bridge screw
493 261	Hour wheel ring (Thickness 0.05 mm, silver)	012 198	Circuit block screw
493 262	Hour wheel ring (Thickness 0.07 mm, gold)	012 198	Coil block screw
701 140	Fifth wheel & pinion	012 793	Setting lever spring screw
4001 310	Circuit block	017 533	Minute wheel pin
4002 302	Coil block	017 621	Tube for train wheel bridge (A)
4146 302	Step rotor	017 622	Tube for train wheel bridge (B)
4216 305	Insulator for circuit block	017 623	Tube for circuit block screw (A)
4225 302	Battery clamp	017 624	Tube for coil block screw
4238 302	Switch lever spring	017 625	Tube for circuit block screw (B)
		017 626	Tube for circuit block screw (C)
		SEIZAIKEN TR726W	Battery

Remarks:

- * Fourth wheel and pinion, Center minute wheel with cannon pinion and Hour wheel.

There are two different types as specified below.

Combination:

Type	Fourth wheel and pinion	Center minute wheel with cannon pinion	Hour wheel
a	 *241 305	 *270 305	Gold  *271 266
b	 *241 299	 *270 303	Silver  *271 303

As of December, 1982, the type b combination is not used. However it may be employed in with certain case designs.

- * Circuit block cover for Pulsar Watches
4457307 (Pulsar marking)