

# PARTS CATALOGUE/TECHNICAL GUIDE

## Cal. V694A

# PARTS CATALOGUE

Cal. V694A

### [SPECIFICATIONS]

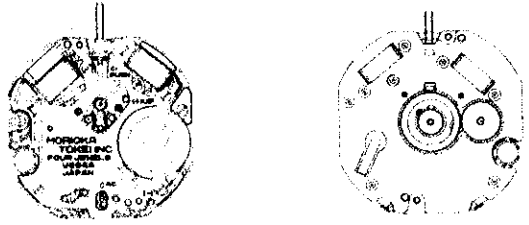
Item		Cal. No.	V694A
Movement			 <p style="text-align: center;">(x 1.0)</p>
Movement size	Outside diameter	24.0mm between 6 o'clock and 12 o'clock sides 24.0mm between 3 o'clock and 9 o'clock sides	
	Casing diameter	ø25.5mm	
	Height	2.6mm	
Time indication		2 hands and mode indicator	
Driving system		Step motor (Fixed-width pulse system, 2 pcs.)	
Additional mechanism		<ul style="list-style-type: none"> <li>• Electronic circuit reset switch</li> <li>• Alarm (12-hour indication system)</li> <li>• Stopwatch (Up to 60 minutes in 1/5 seconds)</li> <li>• Countdown timer (Up to 60 minutes in seconds)</li> <li>• Hands 0-reset adjustment function</li> <li>• Alarm test system</li> <li>• Demonstration movement of the hands</li> </ul>	
Loss/gain		Monthly rate at normal temperature range: less than 20 seconds	
Regulation system		Trimmer condenser	
Measuring gate by quartz tester		Use 60-second gate.	
Battery		SEIKO SR920W, Maxell SR920W Battery life is approximately 2.5 years. Voltage: 1.55V	
Jewels		4 jewels	

SEIKO CORPORATION

Disassembling procedures Figs. : ① → ③⑦  
 Reassembling procedures Figs. : ③⑦ → ①

**Lubricating: Types of oil**      **Oil quantity**

○ ○ Silicone oil 500,000 c.s.      ○ ○ Normal quantity

● Moebius A

○ ○ SEIKO Watch Oil S-6

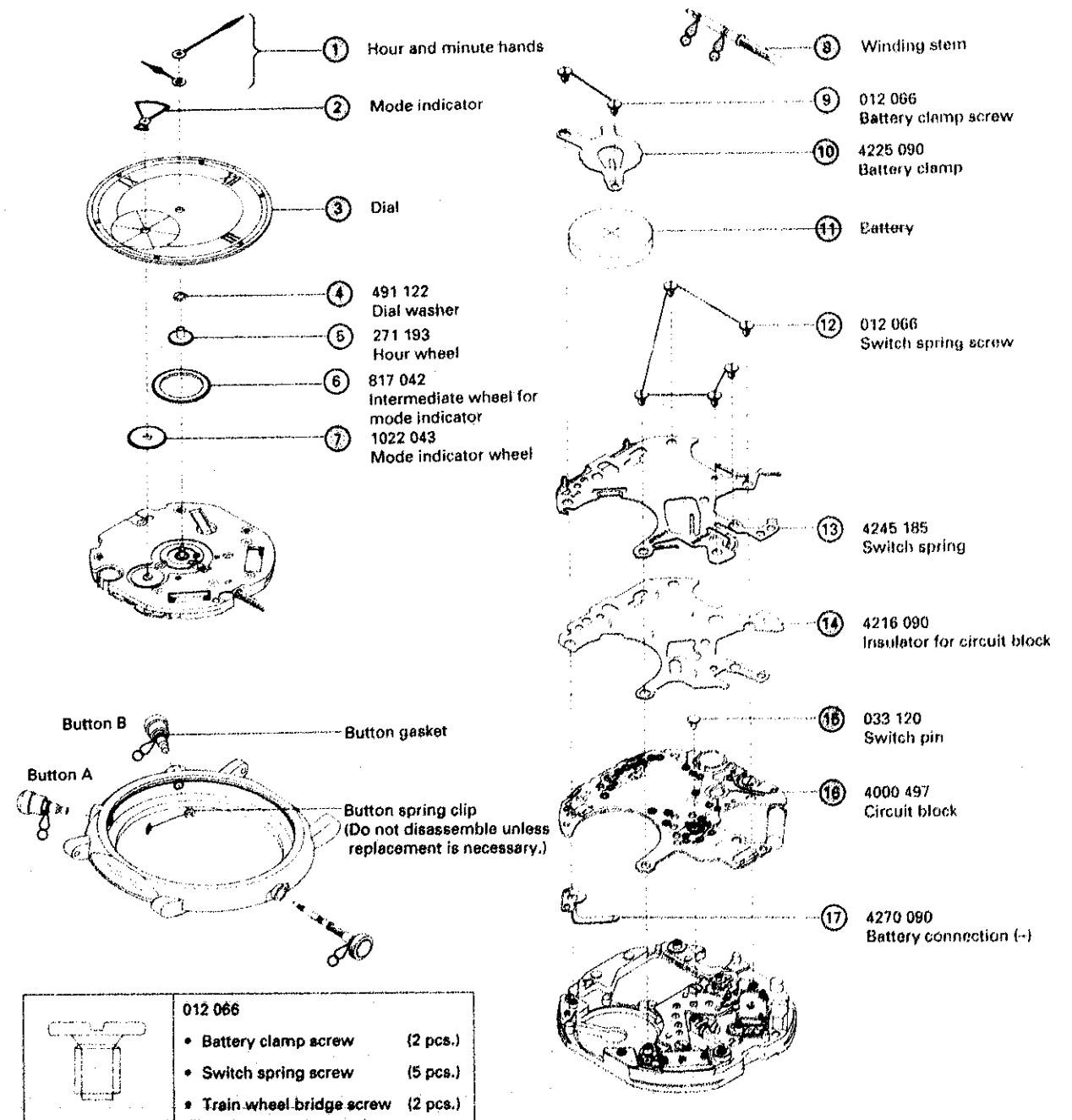

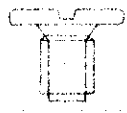
	012 066
• Battery clamp screw	(2 pcs.)
• Switch spring screw	(5 pcs.)
• Train wheel bridge screw	(2 pcs.)

⊙ → Please see the remarks on the following pages.

# PARTS CATALOGUE

Cal. V694A

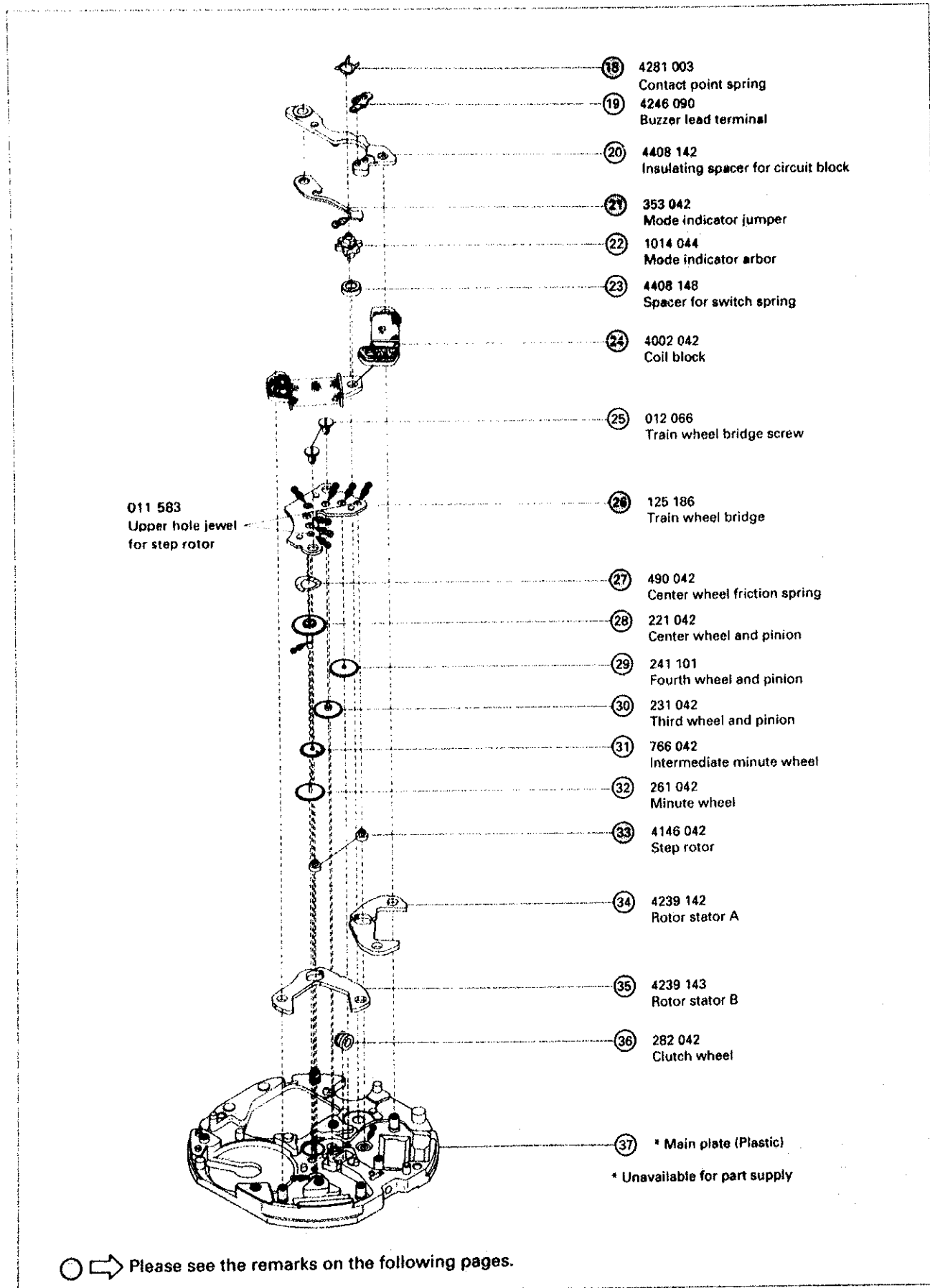

# PARTS CATALOGUE

Cal. V694A

## Remarks:

⑧ Winding stem 351 148

The type of winding stem is determined based on the design of case.  
Check the case number and refer to "Casing Parts Catalogue" to choose a corresponding winding stem.

• Other parts

Piezoelectric element 4589 650

# TECHNICAL GUIDE

Cal. V694A

- The explanation here is only for the particular points of Cal. V694A.
- For the repairing, checking and measuring procedures, refer to the "TECHNICAL GUIDE, GENERAL INSTRUCTIONS".

## I. STRUCTURE OF THE CIRCUIT BLOCK

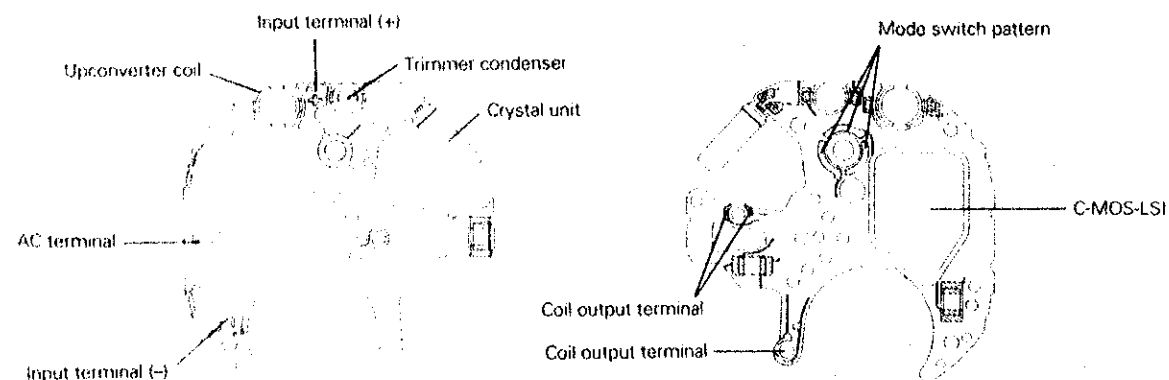

## II. REMARKS ON DISASSEMBLING AND REASSEMBLING

### ① Hands

Since a plastic main plate is used, place the movement on a flat metal plate or the like, and then install the hands at the 12 o'clock position. In doing so, check that the buzzer lead terminal and the two protrusions of the switch spring are not pressed down as they protrude toward the case back side.

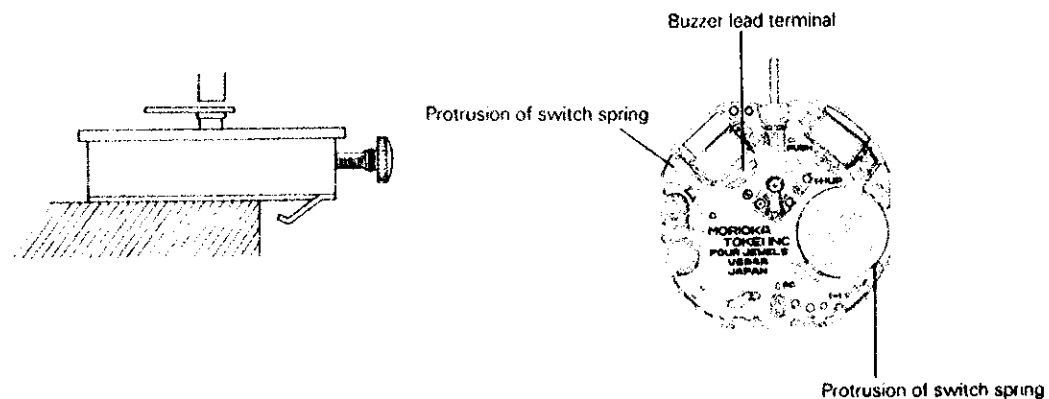

# TECHNICAL GUIDE

Cal. V694A

## ② Mode indicator

- **How to remove** (Applicable to the fan-shaped mode indicator)

Set a hand-removing jig at the center of the mode indicator to remove it. In doing so, check that the hand-removing jig is set right at the center of the mode indicator. Otherwise, the mode indicator may be deformed.



- **How to install**

Make sure that the mode indicator and the mode indicator arbor are set as shown below.

- (1) Turn the crown to set the notched portion of the mode indicator arbor at the 6 o'clock position.

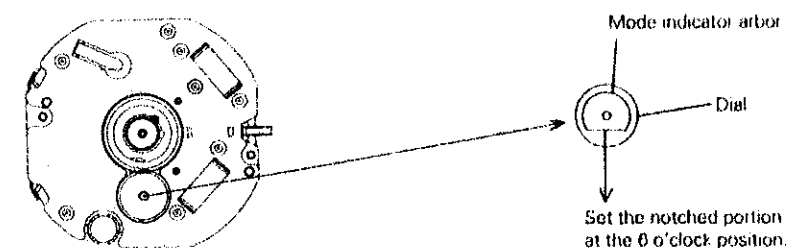

- (2) Install the mode indicator so that it points to "TIME". Refer to the illustrations below, as the shape of the mode indicator and dial differ depending on the models.

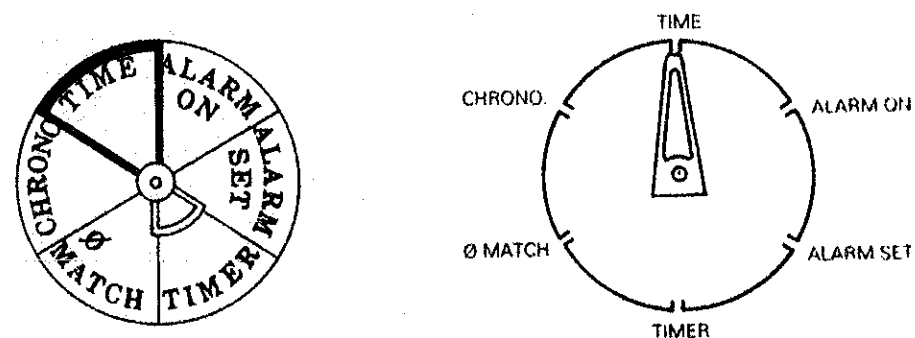

# TECHNICAL GUIDE

Cal. V694A

- (3) After installing the mode indicator, give it three full turns by turning the crown to check if it stops exactly at the respective mode positions. If the mode indicator arbor is loose in the contact with the mode indicator's pipe, the mode indicator will stop out of the proper positions. In that case, slightly flatten the mode indicator's pipe at the part indicated in the illustration, and then install the mode indicator to the mode-indicator arbor again.

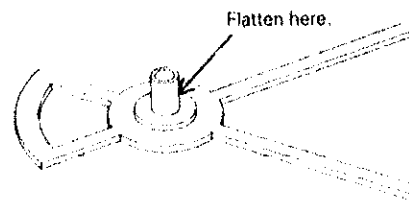

## ③ Dial

### • How to remove

Pry up the dial at the two recessed parts indicated in the illustration using a screwdriver.

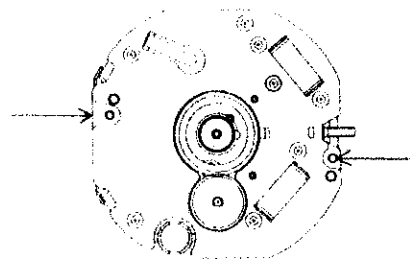

## ④ Dial washer

## ⑦ Center wheel friction spring

### • How to distinguish the two parts

[Dial washer]



- Bent
- With the smaller diameter

[Center wheel friction spring]



- Bent
- With the larger diameter

# TECHNICAL GUIDE

Cal. V694A

## ⑦ Mode indicator wheel

### • How to install

Set the mode indicator wheel to the mode indicator arbor so that it fits in with the notched part of the mode indicator arbor.

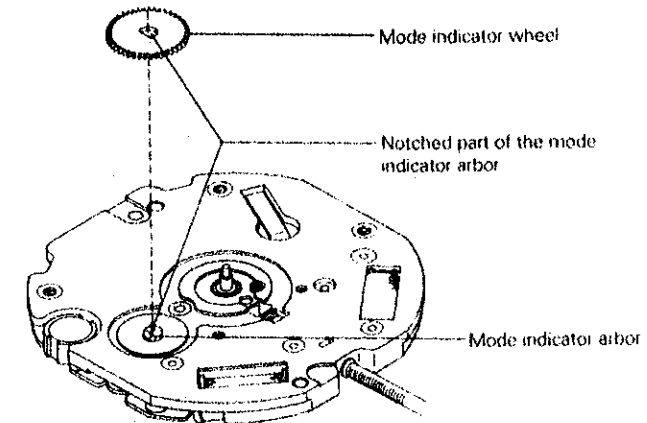

## ⑧ Winding stem

### • How to remove

Remove the winding stem while pushing the indented portion of the switch spring (marked with "← PUSH").

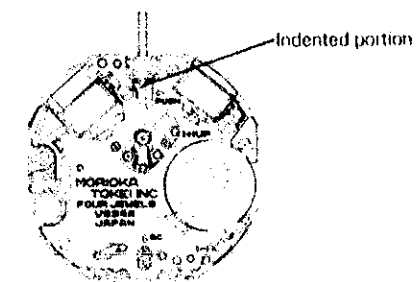

## ⑩ Battery clamp

### • How to install

Slip the tip of the battery clamp into a gap under the switch spring.

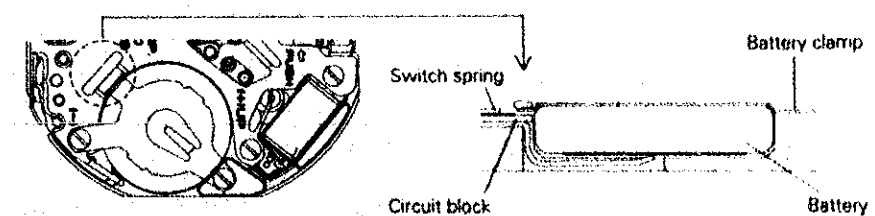

# TECHNICAL GUIDE

Cal. V694A

## ⑪ Battery

### • A necessary step after installing the battery

After the battery is replaced with a new one, or after the battery is removed and re-installed following the repairing procedures, be sure to short-circuit the AC terminal of the circuit block and the battery clamp twice with conductive tweezers to reset the circuit. (When checking the current consumption, short-circuit with the power supplied from external source.)

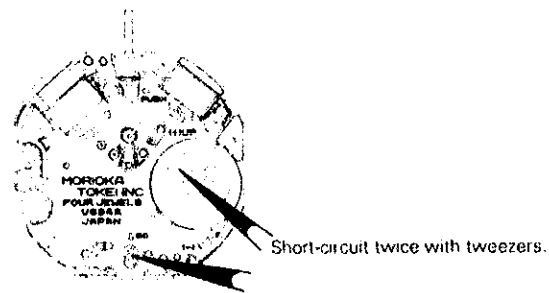

\* The circuit can be reset with a complete watch. Follow the procedure below.

- [1] Turn the crown to set the mode indicator to "Ø MATCH".
- [2] Pull out the crown to the first click.
- [3] Keep buttons "A" and "B" pressed at the same time for approximately 3 seconds. When the buttons are released, a beep sounds and the hour and minute hands start moving counterclockwise and clockwise, respectively.
- [4] Press button "A" or "B" once to stop the hands.
- [5] Press button "A" and "B" repeatedly but separately to reset the minute and hour hands respectively to the "0" position (12 o'clock position).
- [6] Turn the crown to set the mode indicator to "TIME". Then, pull out the crown to the first click, and press button "A" and "B" repeatedly but separately to set the minute and hour hands respectively to the desired time.

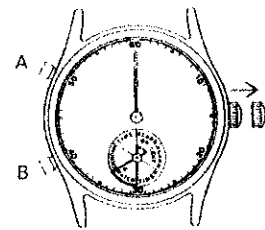

## ⑭ Insulator for circuit block

The insulator for circuit block is colorless and transparent. Therefore, make sure that it is installed without fail.

# TECHNICAL GUIDE

Cal. V694A

## ⑮ Switch pin

If failure of time setting or hands 0-reset adjustment function occurs with the crown at the first click, check if proper clearance is provided between the switch pin and circuit block.

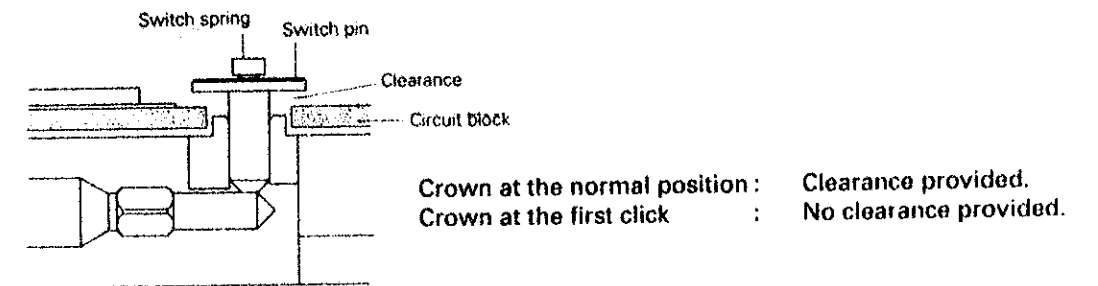

## ⑯ Circuit block

## ⑰ Contact point spring

If a malfunction occurs in any of the modes, check the following points.

- [1] Check if the following parts are set as shown below.

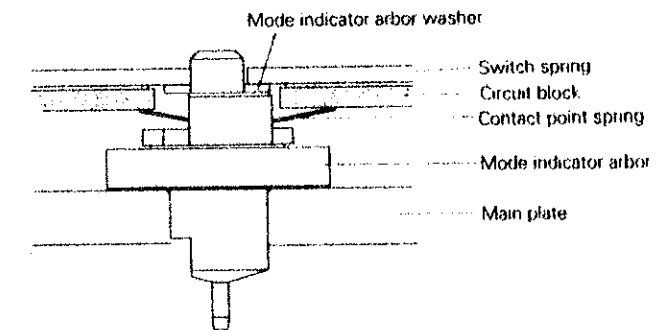

- [2] Check if the contact point spring is deformed.

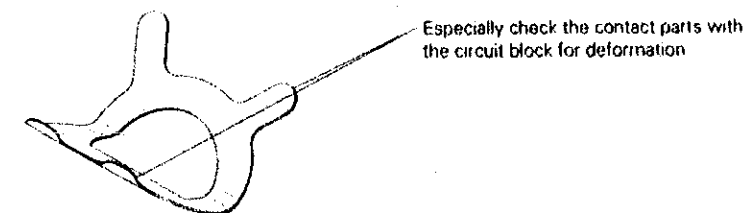

# TECHNICAL GUIDE

Cal. V694A

## 21 Mode indicator jumper

Take care not to deform the mode indicator jumper when disassembling or reassembling it, as extremely high pressure is applied to it.

### • How to remove

Release the tip of the mode indicator jumper from the mode indicator arbor, and then lift up "A" portion in the illustration.

### • How to install

Reverse the procedures for disassembling.

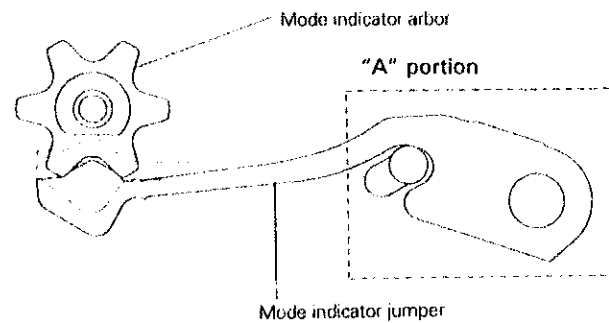

## 24 Coil block

Two coil blocks can be used interchangeably.

## 26 Train wheel bridge

## 27 Center wheel friction spring

## 33 Step rotor

### • Setting position of the train wheel

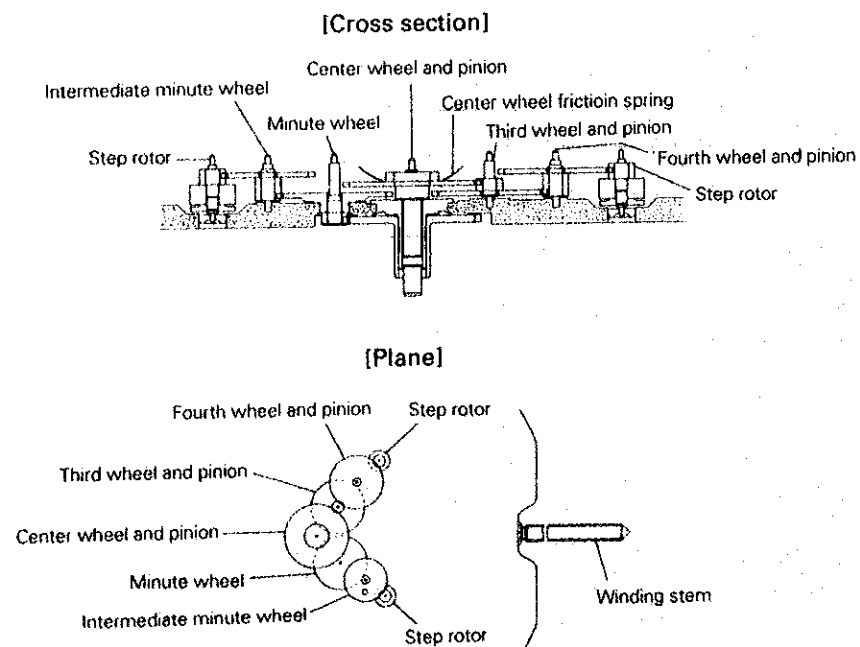

# TECHNICAL GUIDE

Cal. V694A

- Do not deform the center wheel friction spring, as this will cause the watch to stop or lose.
- Two step rotors can be used interchangeably.
- Distinction of wheels

Name	Center wheel and pinion	Third wheel and pinion	Fourth wheel and pinion	Intermediate minute wheel	Minute wheel
Shape					
Distinctive feature	Tall in height	Short pinion	Long pinion	A hole on wheel	No pivot

## III. VALUE CHECKING

- Coil block resistance  
1.2KΩ ~ 1.6KΩ
- Upconverter coil resistance  
120Ω ~ 180Ω
- Measuring time accuracy

Turn the crown to set the mode indicator to "TIME" or "ALARM ON". Since the minute hand moves at 12-second intervals, use 60-second gate of the quartz tester to measure accuracy.

\* Time accuracy can also be measured with the mode indicator set at "TIMER" or "CHRONO". In this case, any gate of the quartz tester can be used to measure the daily rate.

- Current consumption

For the whole of the movement: less than 2.5μA  
For the circuit block alone : less than 1.6μA

**Note:** Before measuring current consumption, it is necessary to reset the circuit with the power supplied from an external source. Therefore, follow the procedures below to measure the current consumption.

# TECHNICAL GUIDE

Cal. V694A

- Measure the current consumption for the whole of the movement.  
(Make sure that the battery clamp screw is securely tightened.)
  - [1] Install the dial and mode indicator, and turn the crown to set the mode indicator to "TIME" or "ALARM ON".
  - [2] Short-circuit the "AC" pattern of the circuit block and the switch spring twice to reset the circuit.
  - [3] Press button "A" or "B" once.
  - [4] The minute hand start moving at 12-second intervals. Read the maximum value of the current consumption, and calculate the current consumption per second.  
Note that measurement obtained while the hands are not moving corresponds to the current consumption for the circuit block alone.  
(For details, refer to Chapter 5 "MEASUREMENT" of the "TECHNICAL GUIDE, GENERAL INSTRUCTIONS".)