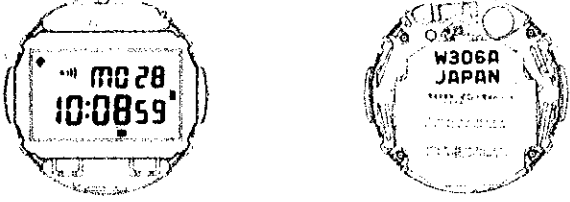

PARTS CATALOGUE/TECHNICAL GUIDE

Cal. W306A

[SPECIFICATIONS]

Cal. No.		W306A
Item	Module	
		
		(x 1.0)
Module size	Outside diameter	φ27.4mm
	Height	4.8mm
Display medium	Nematic Liquid Crystal (Field Effect Mode)	
Liquid crystal driving system	1/3 multiplex driving system	
Display system	<ul style="list-style-type: none"> • Time/calendar display (12- or 24-hour indication) • Time/calendar setting display • Alarm setting display (12- or 24-hour indication) • Stopwatch display (Up to 60 minutes in 1/100 seconds) 	
Additional mechanism	<ul style="list-style-type: none"> • Multi alarm • Hourly time signal • All segments light-up system • Instant calendar setting device • Automatic return system 	
Loss/gain	Monthly rate at normal temperature range: less than 20 seconds	
Regulation system	Nil	
Measuring gate by quartz tester	Any gate can be used.	
Battery	SEIKO CR2016, Maxell CR2016, Sanyo CR2016, Matsushita CR2016, EVEREADY CR2016 Battery life is approximately 5 years. Voltage: 3.0V	

HATTORI SEIKO CO., LTD.

PARTS CATALOGUE

Cal. W306A

Disassembling procedures: Figs. ① ~ ⑮

Reassembling procedures: Figs. ⑮ ~ ①

Lubricating: Types of oil

Oil quantity

● Silicon oil 500,000 c.s.

∞ Normal quantity

① Case back

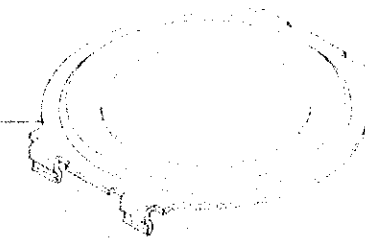

② Case back gasket

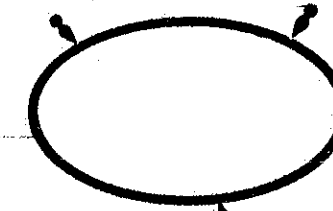

③ Module

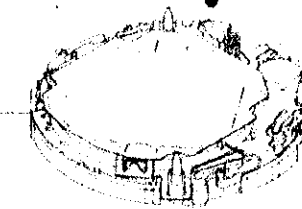

④ Case middle

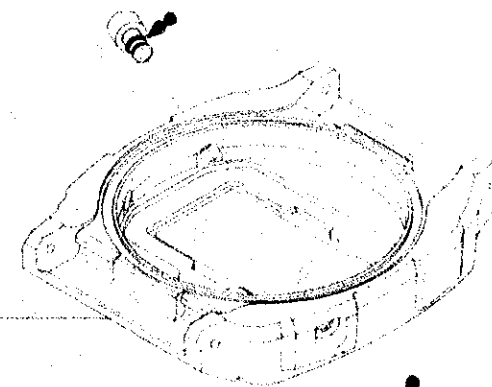

Button (3 pcs.)

○ → Please see the remarks on the following pages.

PARTS CATALOGUE

Cal. W306A

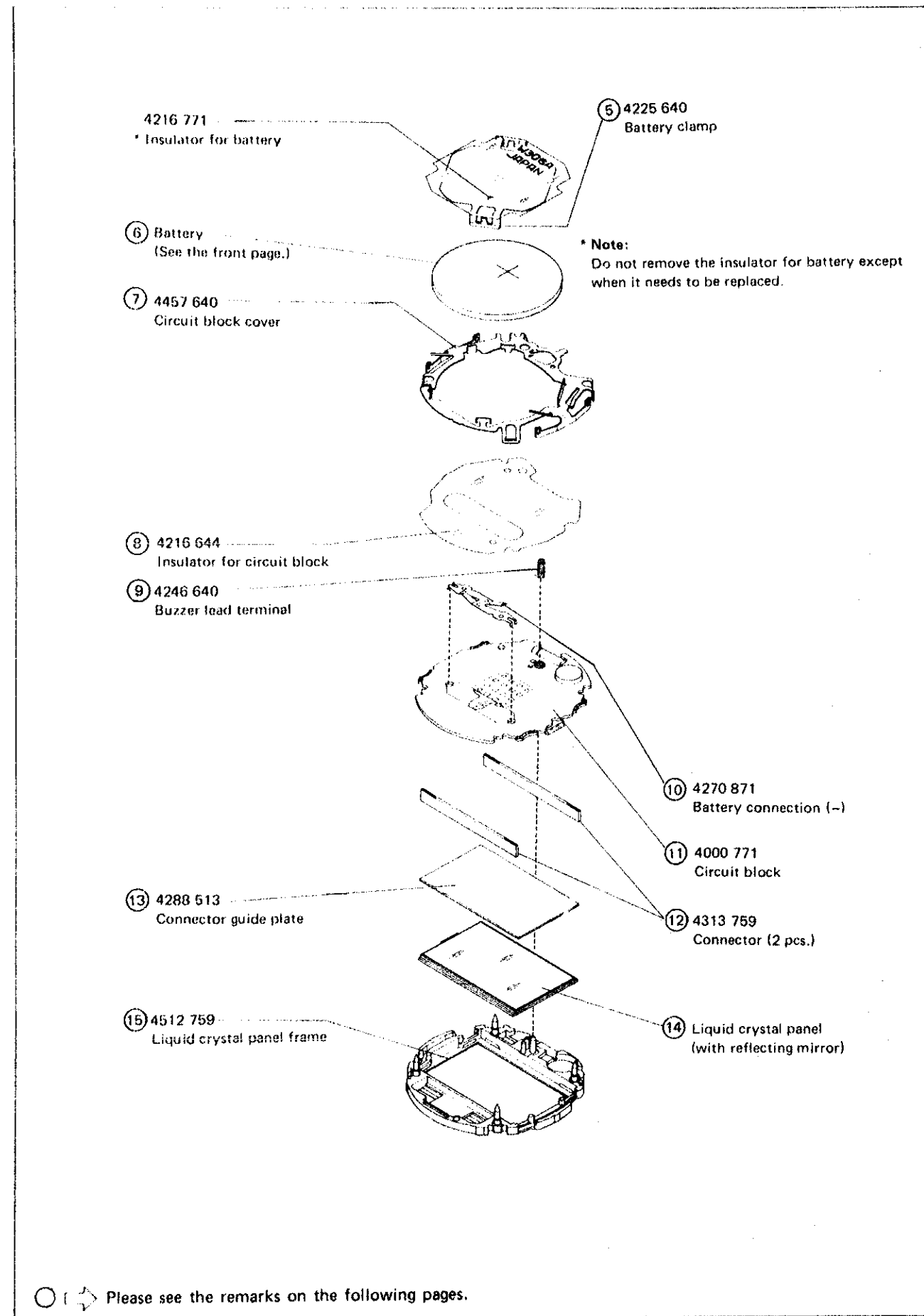

○ ⇨ Please see the remarks on the following pages.

PARTS CATALOGUE

Cal. W306A

Remarks:

- ⑭ Liquid crystal panel
4510 537 (Silver)
4510 538 (Gold)

Be sure to check that combination of the colors of the panel cover and liquid crystal panel is made properly according to the "Casing Parts Catalogue".

- Other parts
Piezoelectric element 4589 650

TECHNICAL GUIDE

Cal. W306A

- The explanation here is only for the particular points of Cal. W306A.
For detailed checking and adjustment, refer to the "TECHNICAL GUIDE AND PARTS LIST CAL. W309A".
- For the normal repairing, checking and measuring procedures, refer to the "TECHNICAL GUIDE, GENERAL INSTRUCTIONS".

I. STRUCTURE OF THE CIRCUIT BLOCK

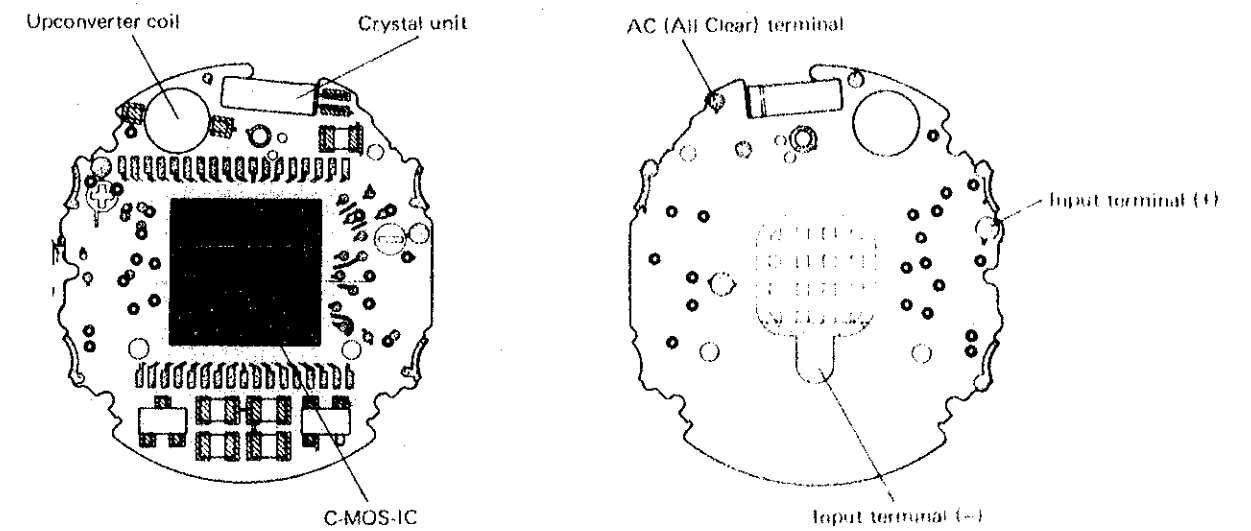

II. RELATIONSHIP BETWEEN THE SEGMENT (LIQUID CRYSTAL PANEL ELECTRODE) AND THE C-MOS-LSI OUTPUT TERMINAL

• Designation of the segment

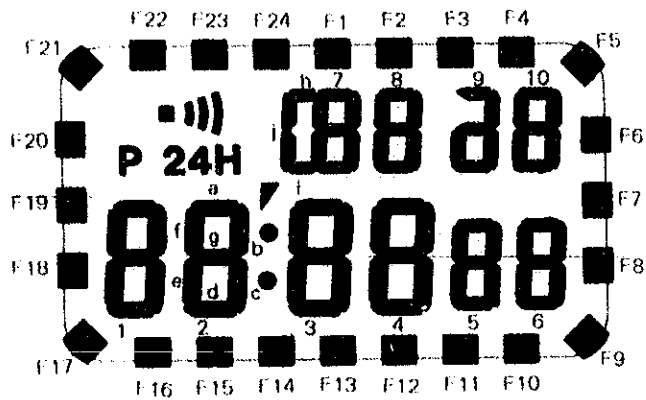

• Segment (Liquid crystal panel electrodes)

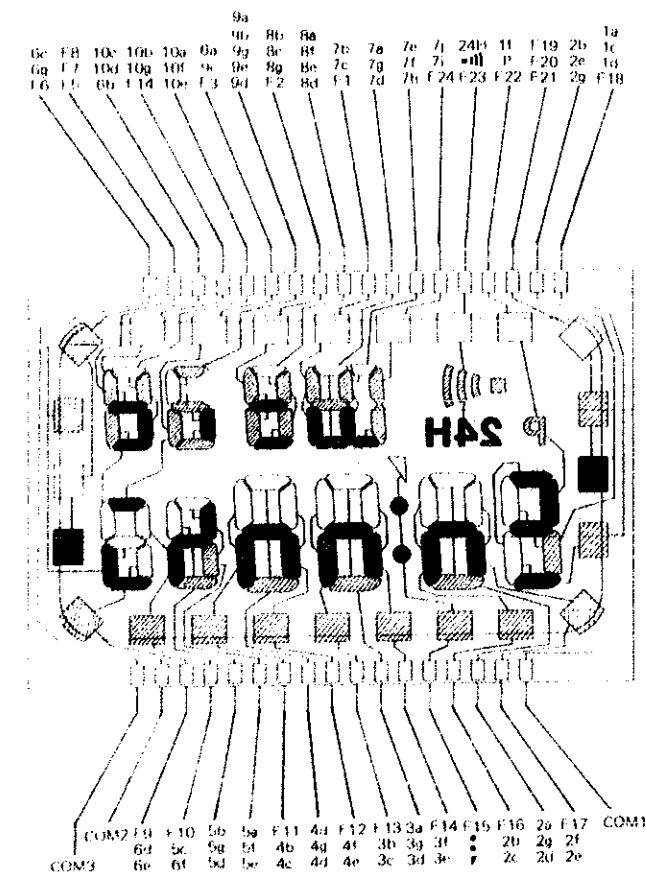

• C-MOS-LSI output terminal

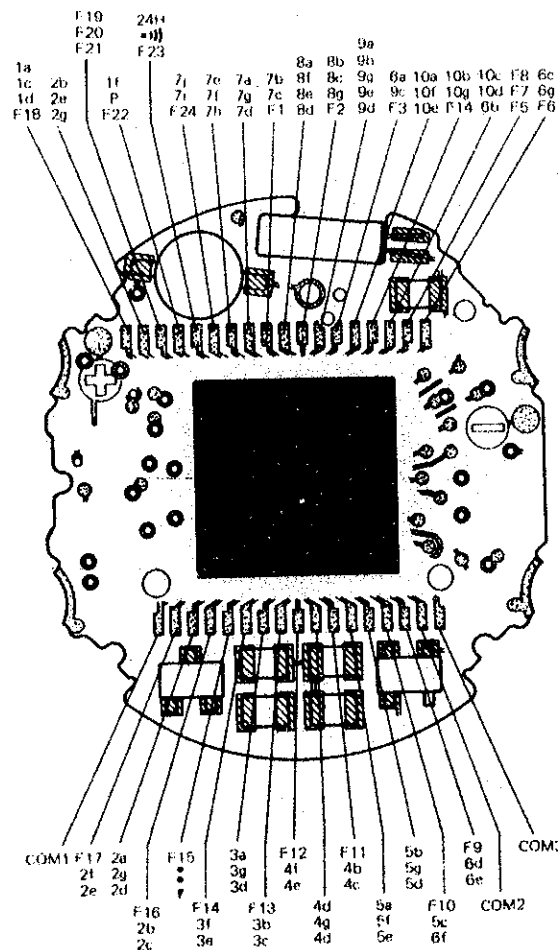

III. REMARKS ON INSTALLING THE BATTERY

After the battery is replaced with a new one, or after the battery is re-installed following the repairing procedures, be sure to short-circuit the system reset pattern and battery (+) surface with conductive tweezers as indicated in the illustration below to reset the circuit. The watch will be set in the following conditions, so press the buttons to set the TIME/CALENDAR.

Display	:	TIME display
Alarm/hourly time signal	:	Disengaged
Multi alarm	:	Disengaged
Time display	:	12:00'00" A.M.
Calendar display	:	January 1, Sunday
Alarm time	:	12:00 A.M.
Stopwatch	:	Reset to "00"

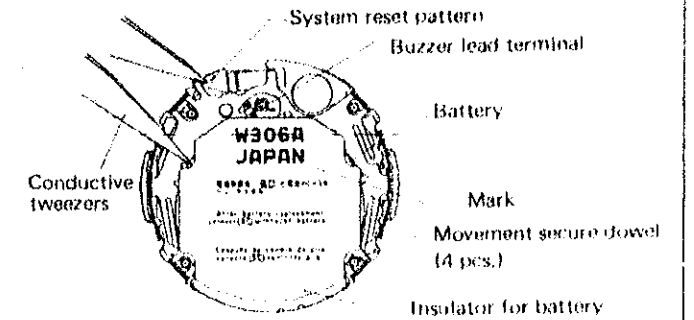

IV. REMARKS ON DISASSEMBLING AND REASSEMBLING

② Case back gasket

Apply silicone oil to the case back gasket.

④ Case middle

• Notes on replacing the buttons

- 1) Do not remove the buttons except when they need to be replaced with new ones for repair.
- 2) When removing the buttons, be sure to replace them with new ones.
- 3) When replacing the buttons with new ones, be sure to apply silicone oil to the new buttons.

⑤ Battery clamp

• How to remove

Release the battery clamp from the circuit block cover by inserting the tip of tweezers as shown in the illustration at right.

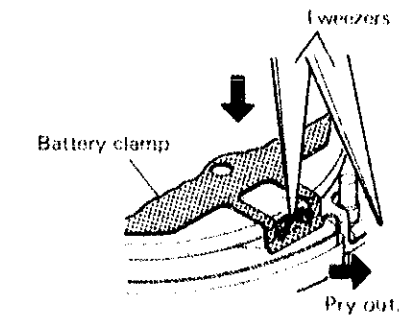

• How to install

Set "A" portion of the battery clamp to the circuit block cover, checking that there is no clearance between them, and then hook the opposite portion to the protrusion of the circuit block cover as shown in the illustration at right.

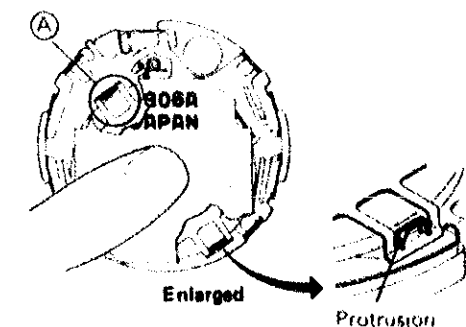

⑦ Circuit block cover

● How to remove

Pry up the circuit block cover from the liquid crystal panel at the four hooking portions ("B" portions) with tweezers as shown in the illustration at right.

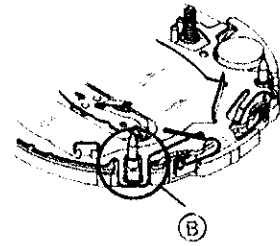

⑨ Buzzer lead terminal

● How to install

Put the tip of the buzzer lead terminal between the two protrusions of the liquid crystal panel frame as indicated in the illustration at right.

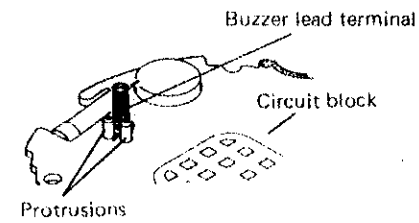

V. VALUE CHECKING

● Coil block resistance

$50\Omega \sim 90\Omega$

● Current consumption

For the whole of the module : less than $1.7\mu A$

For the circuit block alone : less than $1.5\mu A$