

TECHNICAL GUIDE AND PARTS LIST

CAL. Y961A

COMBINATION QUARTZ

CONTENTS

I. FOREWORD	1
1. System reset after replacing the battery	1
2. Notes on circuit block installation	1
II. SPECIFICATIONS	2
III. SCREWS USED	2
IV. OPERATION	3
V. DISASSEMBLING, REASSEMBLING AND LUBRICATING	4
1. Case middle ~ Movement	4
2. Rear side of the movement (Liquid crystal panel holder screw ~ Coil lead terminal)	5
3. Front side of the movement (Battery clamp screw - Winding stem)	6
VI. CHECKING AND ADJUSTMENT	7
1. Structure of circuit block	7
2. Relationship between the segments (Liquid crystal panel electrodes) and C-MOS-LSI output terminals	7
3. Procedures for checking and adjustment	8 ~ 10
VII. PARTS LIST	11

FOREWORD

NOTE:

The Cal. Y961 is the model based on Cal. Y960 and employs the timer function. The parts of the Cal. Y961, except the circuit block and coil block cover, are the same as those of Cal. Y960. Therefore, the disassembling, reassembling, checking and adjustment procedures are the same.

1. System reset after replacing the battery

The Cal. Y961A requires the system reset procedure, because the incorrect display shows on the liquid crystal panel, when the battery is replaced. At that time, perform the system reset as follows.

< System reset procedure >

Contact the battery (+) surface and AC (All Clear) terminal with conductive tweezers as shown below. (A label which gives the procedure is attached to the battery clamp.)

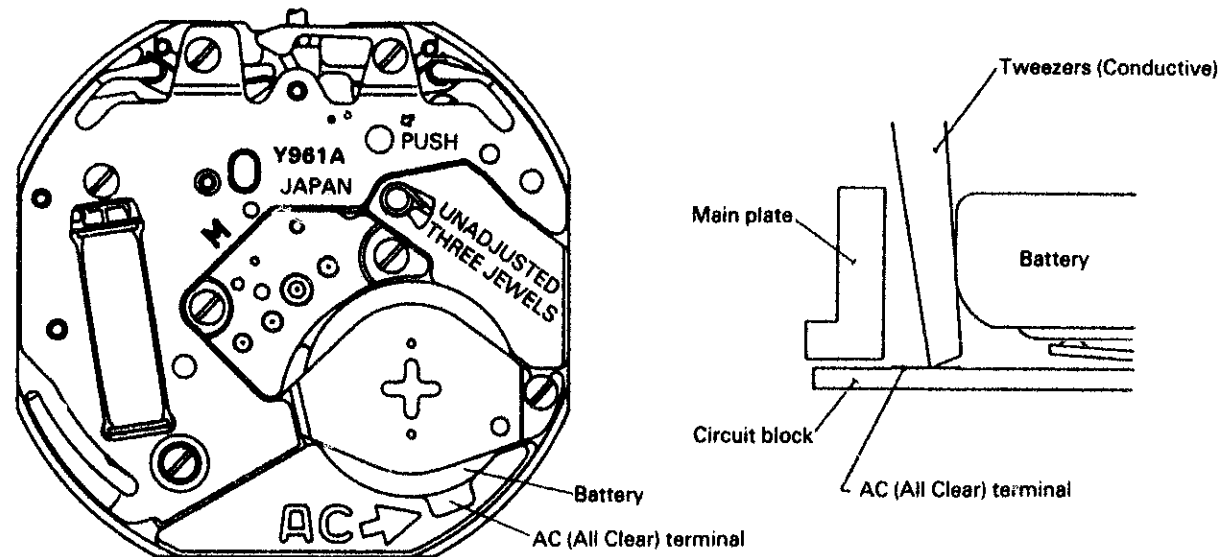

2. Notes on circuit block installation

Three switch pins are soldered to the circuit block to make the contact with the switch lever and yoke. When the circuit block is reassembled, proceed as follows.

- (1) Set the crown at the normal (fully inserted) or second click (fully pulled) position.
- (2) Rotate the crown so that the winding stem cam does not make contact with switch lever (Figure below).

Viewed from the 3 o'clock position

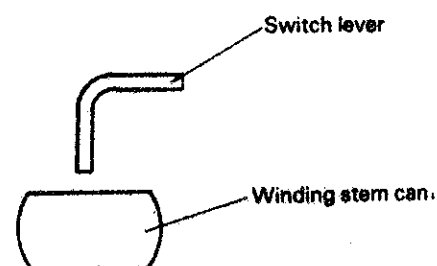

II. SPECIFICATIONS

Item	Cal. No.	Y961A	
		Analogue section	Digital section
Display medium		Three hands	Nematic Liquid Crystal, FEM (Field Effect Mode)
Drive system		Step motor	Multiplex driving
Display system			Time display Calendar display Alarm time display Timer display
Additional mechanism		Second setting device Electric circuit reset switch	Alarm test system
Loss/gain		Monthly rate: less than 20 seconds at normal temperature range	
Movement size	Size of main plate	ø26.4 mm (3H - 9H 23.5 mm, 12H - 6H 24.2 mm)	
	Casing diameter	ø25.6 mm (3H - 9H 23.5 mm, 12H - 6H 24.2 mm)	
	Height (including battery)	3.55 mm	
Regulation system		-	
Measuring gate		Any gate is available	
Battery		SEIKO SR920W, MAXELL SR920W Voltage: 1.55V Battery life: Approx. 2 years	
Jewels		3 jewels	

III. SCREWS USED

In Cal. Y961A, two types of screws are used. The head diameter differs from each other as shown in the table below. Note the difference for disassembly and reassembly.

Parts code	Appearance	Description and number	Difference	
022 247		Setting lever spring screw.....	1 pce.	Large head
		Train wheel bridge screw.....	2 pcs.	
		Coil block cover screw.....	4 pcs.	
		Circuit block screw.....	1 pce.	
		Anti-magnetic shield plate screw.....	2 pcs.	
Battery clamp screw.....	1 pce.			
022 248		Liquid crystal panel holder screw.....	4 pcs.	Small head

IV. OPERATION

1. DISPLAY AND CROWN OPERATION

The digital display changes by turning the crown clockwise or counterclockwise at the normal position, as shown below:

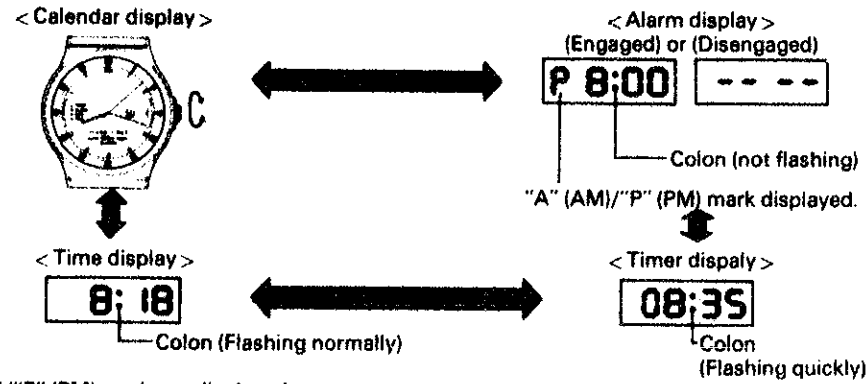

* "A" (AM)/"P" (PM) mark not displayed.
(Displayed with the crown pulled out to the first click)

2. HOW TO SET THE ANALOGUE TIME

- In the time display, pull the crown out to the second click when the second hand is at the 12 o'clock position, and the second hand stops on the spot.
- Turn the crown clockwise to advance the hands, and counterclockwise to turn them back.
- Push the crown in to the normal position in accordance with a time signal, and the second hand starts immediately.

3. HOW TO SET THE ANALOGUE SECOND HAND AND DIGITAL SECONDS

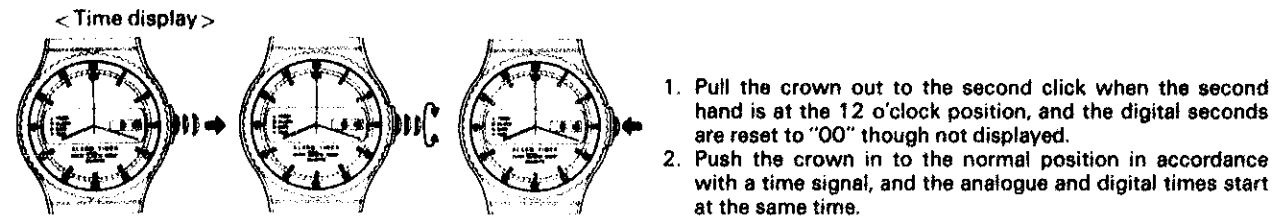

4. HOW TO SET THE DIGITAL DISPLAY

In each of the following displays, pull the crown out to the first click position and proceed as follows in setting the digital section.

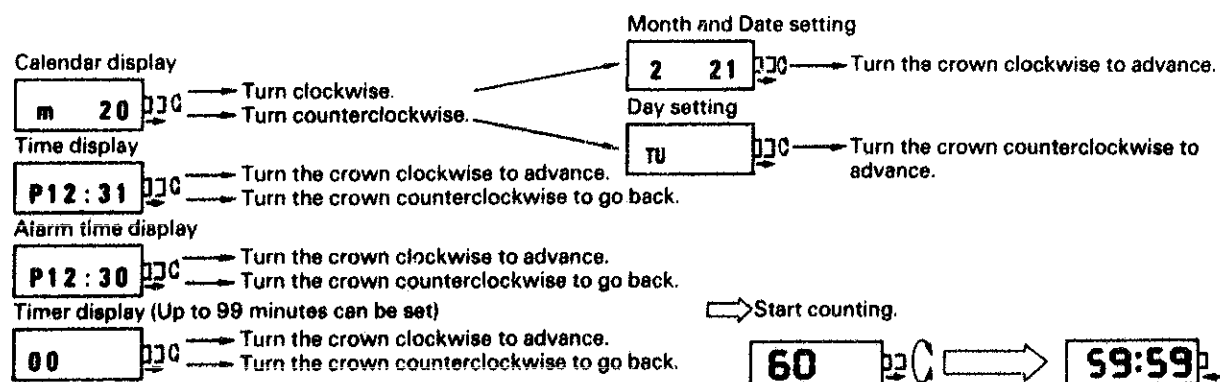

< Pattern segment checking display >
All segments are simultaneously displayed, when the crown is alternately turned clockwise and counterclockwise at normal position in the time display and the crown is pulled to the first click position.
The operation described above should be performed within one or two seconds.

< Alarm engagement and disengagement >

- In the alarm display, pull the crown out to the first click and push it in again.
- With each pulling out and pushing into the crown, the alarm is alternately engaged and disengaged.

< Alarm test >

- In the alarm display, pull the crown out to the first click and push it in to the normal position again.
The alarm can be tested once with a "pip-pon" sound.
- Note that the alarm will also be engaged or disengaged by the alarm test crown operation.

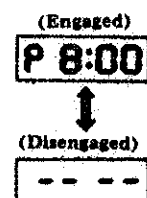

NOTE: FOR DETAILS, REFER TO THE INSTRUCTION BOOKLET. Cal Y961.

V. DISASSEMBLING, REASSEMBLING AND LUBRICATING

1. Case middle ~ Movement

Lubricating: Moebius A

Disassembling procedures: Figs ① ~ ④
Reassembling procedures: Figs ④ ~ ①

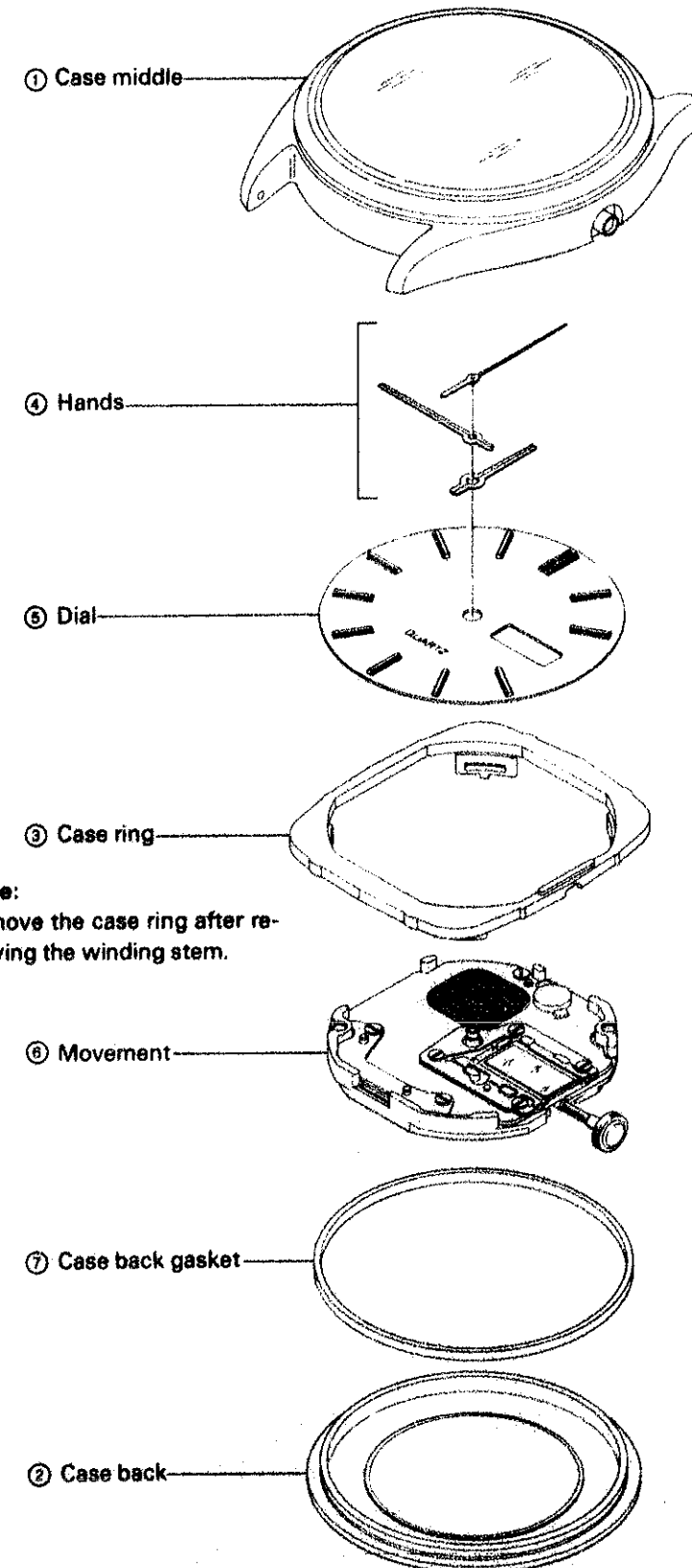

Note:
How to remove the winding stem
Set the crown to the second click position and press the setting lever viewed from the hole shown below to remove the winding stem.

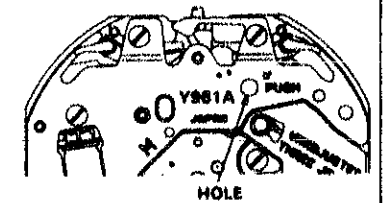

Note:
Remove the case ring after removing the winding stem.

**2. Rear side of the movement
(Liquid crystal panel holder screw ~ Coil lead terminal)**

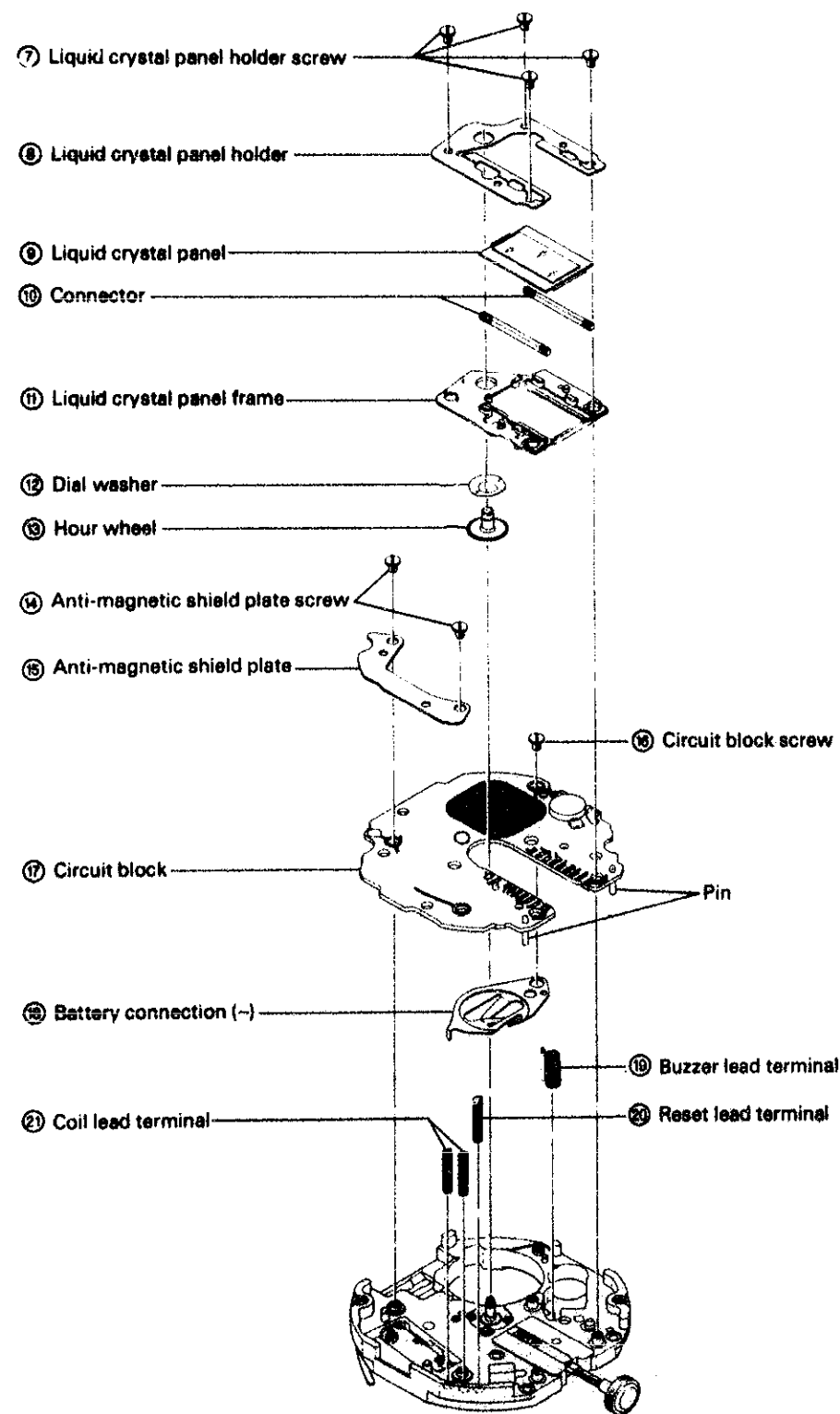

Note:
As the connectors are symmetrical, they can be mounted either position.

Notes on handling the circuit block:
As 3 pins are soldered to the circuit block, take care not to bend or break them.

Note:
The reset lead terminal and coil lead terminal are the common parts and differ from the buzzer lead terminal.

**3. Front side of the movement
(Battery clamp screw - Winding stem)**

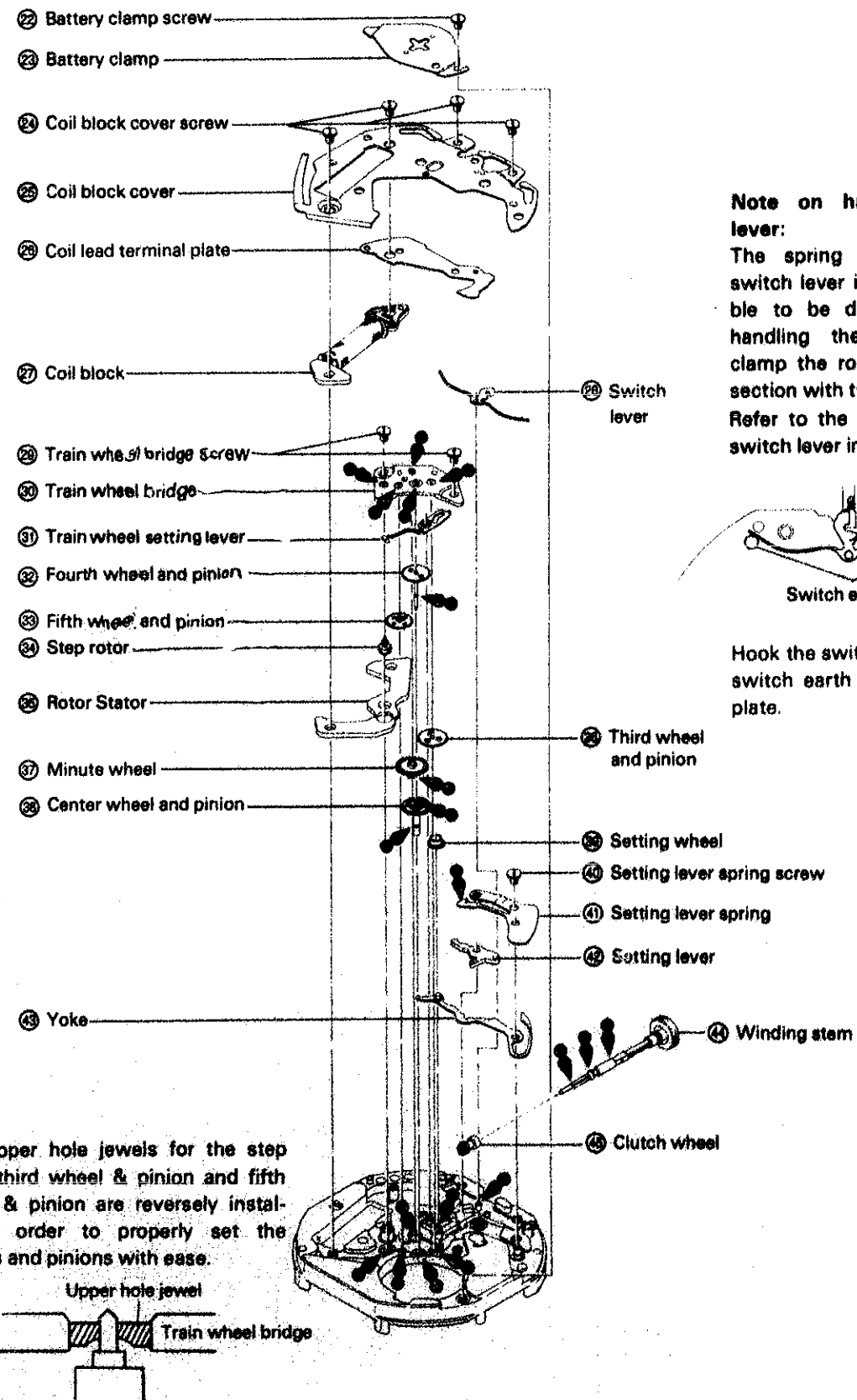

Note on handling switch lever:
The spring section of the switch lever is thin and is liable to be deformed. When handling the switch lever, clamp the root of the spring section with tweezers. Refer to the figure below for switch lever installation.

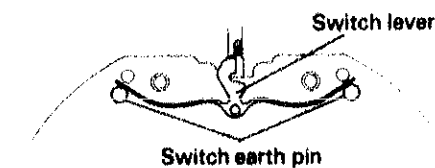

Hook the switch lever with the switch earth pin of the main plate.

Note:
The upper hole jewels for the step rotor, third wheel & pinion and fifth wheel & pinion are reversely installed in order to properly set the wheels and pinions with ease.

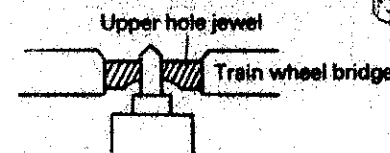

VI. CHECKING AND ADJUSTMENT

1. Structure of circuit block

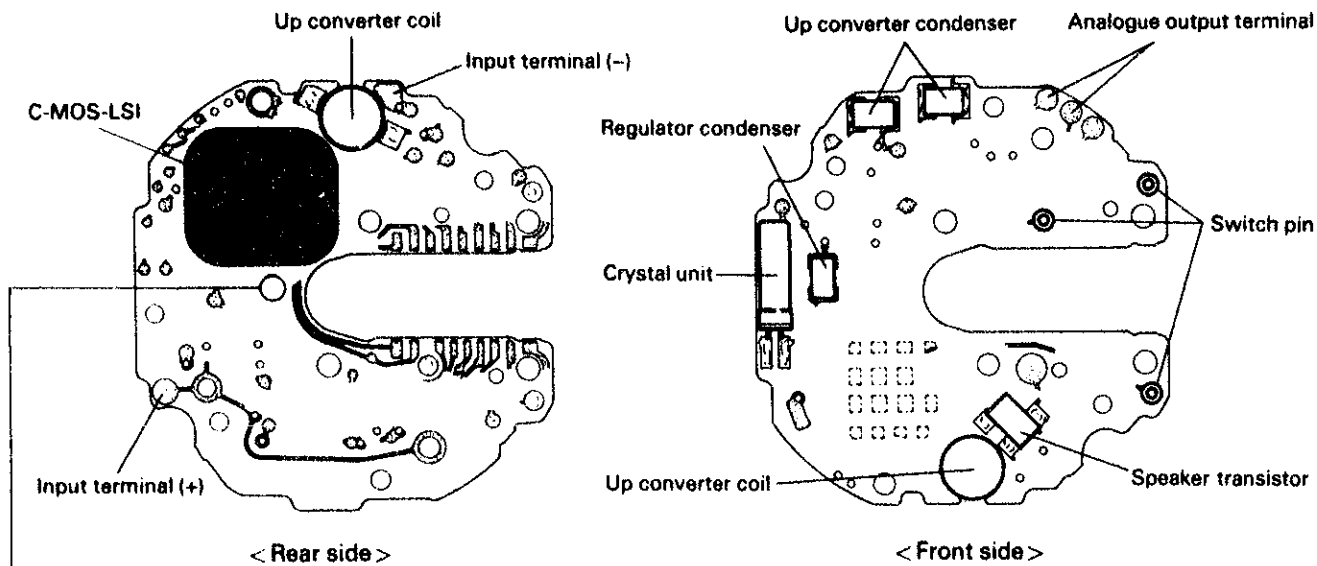

Note:
Circuit block identification mark (white paint).
To classify the circuit block from Cal. Y960

2. Relationship between the segments (Liquid Crystal panel electrodes) and C-MOS-LSI output terminals

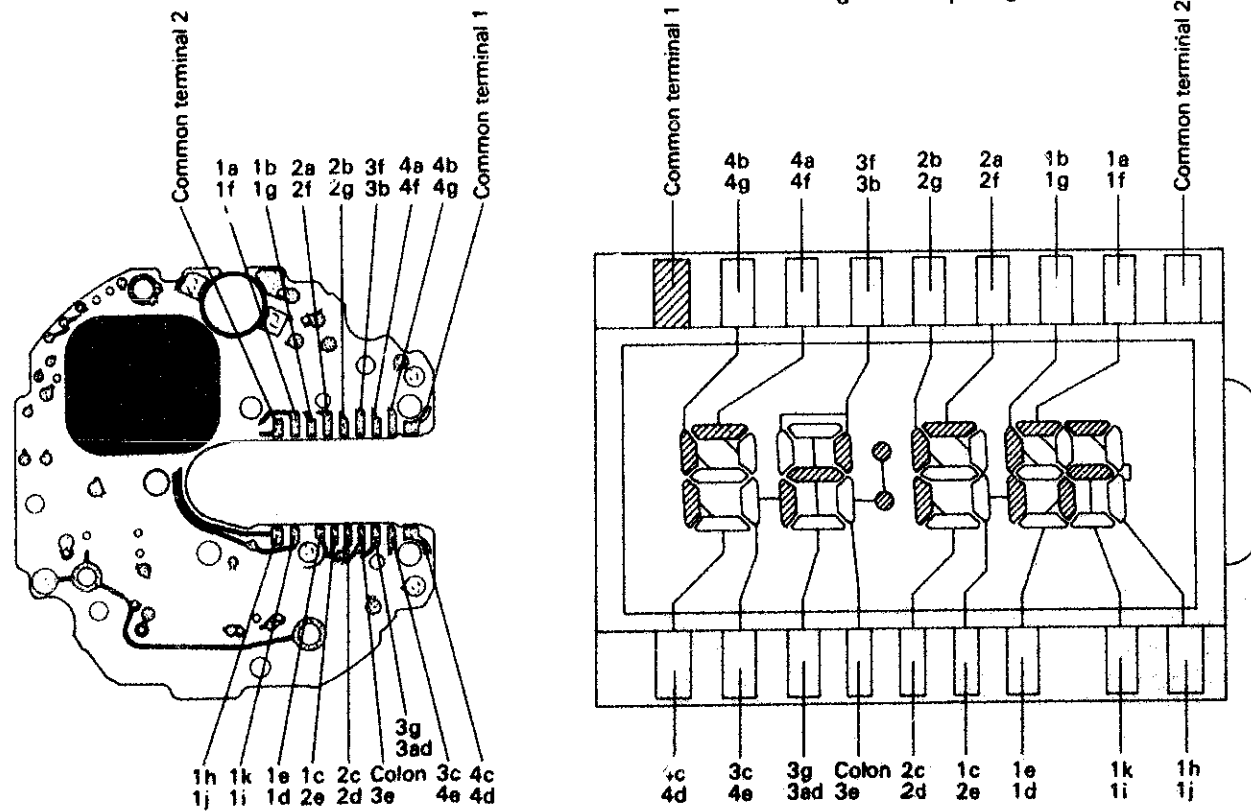
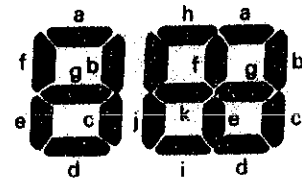

3. Procedures for checking and adjustment

- This section only gives the checking and adjustment procedures exclusive for CAL. Y961A.
- For details, refer to "TECHNICAL GUIDE GENERAL INSTRUCTION".

OUTPUT SIGNAL

Check the output signal of every 1 second with the crown at normal position.

Result:
Output signal Normal
No output signal Defective
Proceed to battery voltage check
→ Battery voltage is normal
..... Check the coil block

BATTERY VOLTAGE

Use the SEIKO Digital Multi Tester S-840A.
Range to be used: DC V

Result:
More than 1.5V Normal
Less than 1.5V Defective
Replace the battery.

BATTERY CONDUCTIVITY

Check the conductivity between the battery and battery connection (-).

CIRCUIT BLOCK CONDUCTIVITY

Check the circuit block output terminal and pattern for contermination in the circuit block, and check if the circuit is broken or short.

GEAR TRAIN MECHANISM

Check the gear train mechanism for play of step rotor, wheels, pinions, dust, lint, and lubrication.

RESET CONDITION

Reassemble the movement and check the reset condition with a quartz tester.

(1) Check the output signal with the crown at normal position.

Result:
Output signal Normal
No output signal Defective
Check the coil lead terminal and proceed to (2)

(2) Check the output signal with the crown at second click position.

No output signal Normal
Output signal Defective
Replace the coil lead terminal plate.

CURRENT CONSUMPTION

- (1) Check the current consumption for the whole of the movement.
 ● Use the SEIKO Digital Multi Tester S-840A and the Multi Adaptor MA-40.

Range to be used: μA

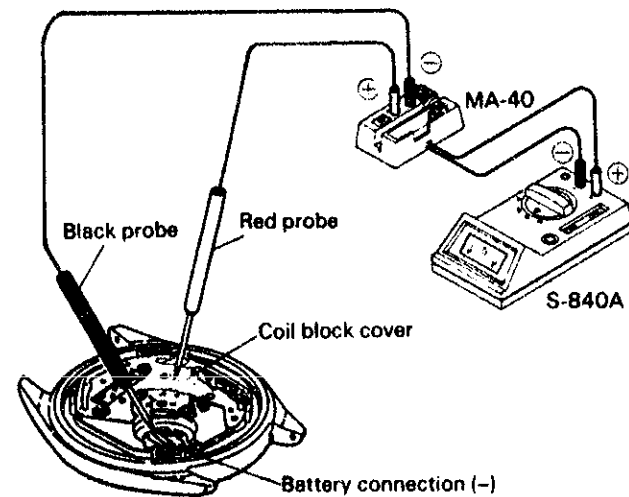

- (2) Check the current consumption for the circuit block alone.
 ● Check in the same manner as in (1).

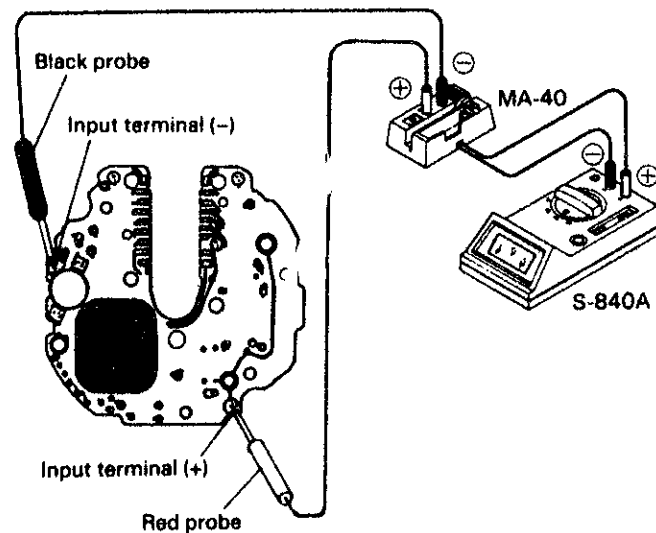

Result:
 Less than $2.3\mu\text{A}$ Normal
 More than $2.3\mu\text{A}$ Defective
 Check the current consumption for the circuit block.

Result:
 Less than $1.1\mu\text{A}$ Normal
 If the coil block is not short circuited, replace the liquid crystal panel.
 More than $1.1\mu\text{A}$ Defective

ACCURACY

- Check with quartz tester and electromagnetic microphone.
- < Measuring >
- Check with the crown at normal position.
 - Set the digital section to calendar or time display mode.

NOTE:

The accuracy can be checked with the digital section. However, the display is small and it is difficult to check the movement. Check the accuracy with the analogue section.

Result:
 Monthly rate
 Less than 20 seconds
 Normal
 More than 20 seconds
 Defective

CONDUCTIVITY BETWEEN C-MOS-LSI AND LIQUID CRYSTAL PANEL

Check the liquid crystal panel electrode, connector and lead terminals for contamination and dust.
 There should be no defect, scratches and damage.

LIQUID CRYSTAL PANEL AND CIRCUIT BLOCK

Referring to the "Relationship between the segments (Liquid crystal panel electrodes) and C-MOS-LSI output terminals (P. 7), check the liquid crystal panel and circuit block.

- (1) Check to see if the corresponding segment of the liquid crystal panel is displayed.

Result:
 Display Normal
 Not display Defective
 Replace the liquid crystal panel.

- (2) Check the circuit block output.

More than 0.8V Normal
 Less than 0.8V Defective
 Replace the circuit block.

ALARM FUNCTION

- (1) Check the contacts of piezoelectric element and buzzer lead terminal for contamination and the buzzer lead terminal for deformation.

- (2) Measure the up converter coil resistance of the circuit block and check for the broken wire and short circuit.
 Use the Digital Multi Tester S-840A.

Result:
 50 ~ 90 Ω Normal
 Less than 50 Ω Defective
 (short circuit)
 More than 90 Ω Defective
 (broken wire)
 Replace the circuit block.

COIL BLOCK

Use the Digital Multi Tester S-840A.
 Range to be used: Ω

Result:
 2.3 ~ 2.8k Ω Normal
 More than 2.8k Ω Defective
 (broken wire)
 Less than 2.3k Ω Defective
 (short circuit)
 Replace the coil block.

FUNCTION

Check the operation referring to the "Operation.", P. 3.

VII. PARTS LIST

Cal. Y961 A			
PARTS NO.	PARTS NAME	PARTS NO.	PARTS NAME
125 755	Train wheel bridge	4246 746	Buzzer lead terminal
* 221 755	Center wheel & pinion	4259 745	Anti-magnetic shield plate
* 221 795	Center wheel & pinion	4270 745	Battery connection (-)
231 755	Third wheel & pinion	4311 745	Coil lead terminal plate
* 241 765	Fourth wheel & pinion	4313 745	Connector
* 241 795	Fourth wheel & pinion	4450 745	Switch lever
261 795	Minute wheel	4462 965	Coil block cover
* 271 765	Hour wheel	* 4510 811	Liquid crystal panel (Silver)
* 271 795	Hour wheel	* 4510 812	Liquid crystal panel (Gold)
281 755	Setting wheel	4512 745	Liquid crystal panel frame
282 795	Clutch wheel	4540 745	Liquid crystal panel holder
* 354 795	Winding stem	011 325	Upper hole jewel for fourth wheel
383 755	Setting lever	011 547	Lower hole jewel for step rotor
384 795	Yoke	011 568	Upper hole jewel for step rotor
388 795	Setting lever spring	022 247	Setting lever spring screw
391 755	Train wheel setting lever	022 247	Train wheel bridge screw
491 725	Dial washer	022 247	Coil block cover screw
701 755	Fifth wheel & pinion	022 247	Circuit block screw
4001 746	Circuit block	022 247	Anti-magnetic shield plate screw
4002 756	Coil block	022 247	Battery clamp screw
4148 755	Step rotor	022 248	Liquid crystal panel holder screw
4225 746	Battery clamp	4589 765	Piezoelectric element
4239 755	Rotor stator	SEIKO SR920W	} Battery
4246 745	Coil lead terminal	MAXELL SR920W	
4246 745	Reset lead terminal		

Remarks:

* Center wheel & pinion, Fourth wheel & pinion, Hour wheel

There are two different types as specified below:

Combination:

*Type	Center wheel & pinion	Fourth wheel & pinion	Hour wheel
M	221 755	241 765	271 765
L	221 795	241 795	271 795

* Abbreviation M.....Standard type
(Movement type) L.....Long Type

* Winding stem

The type of winding stem is determined based on the design of case.

Please refer to "Casing parts catalogue."

* Liquid crystal panel

4510 811

(Silver)

4510 812

(Gold)

Be sure that combination between the color of panel cover and liquid crystal panel should be matched according to the "Casing Parts Catalogue".